



HAL
open science

Coherent beam combining techniques : an introduction

Gaëlle Lucas-Leclin

► **To cite this version:**

Gaëlle Lucas-Leclin. Coherent beam combining techniques : an introduction. Doctoral. France. 2015.
hal-01257035

HAL Id: hal-01257035

<https://hal-iogs.archives-ouvertes.fr/hal-01257035>

Submitted on 2 May 2016

HAL is a multi-disciplinary open access archive for the deposit and dissemination of scientific research documents, whether they are published or not. The documents may come from teaching and research institutions in France or abroad, or from public or private research centers.

L'archive ouverte pluridisciplinaire **HAL**, est destinée au dépôt et à la diffusion de documents scientifiques de niveau recherche, publiés ou non, émanant des établissements d'enseignement et de recherche français ou étrangers, des laboratoires publics ou privés.



Distributed under a Creative Commons Attribution - NonCommercial - NoDerivatives 4.0
International License

Coherent beam combining techniques : an introduction

Gaëlle LUCAS-LECLIN

Associate Professor

gaelle.lucas-leclin@institutoptique.fr

Laboratoire Charles Fabry

*Institut d'Optique, CNRS, Université Paris-Sud 11
(France)*

www.lcf.institutoptique.fr



Coherent beam combining of diode lasers:

WHY ?

WHAT ?

HOW ?

WARUM ?

WAS ?

WIE ?

Outline

- **Introduction**
 - brightness of a laser source
 - beam combining architectures
- **Coherent beam combining**
 - active MOPA configuration
 - self-organising external cavities

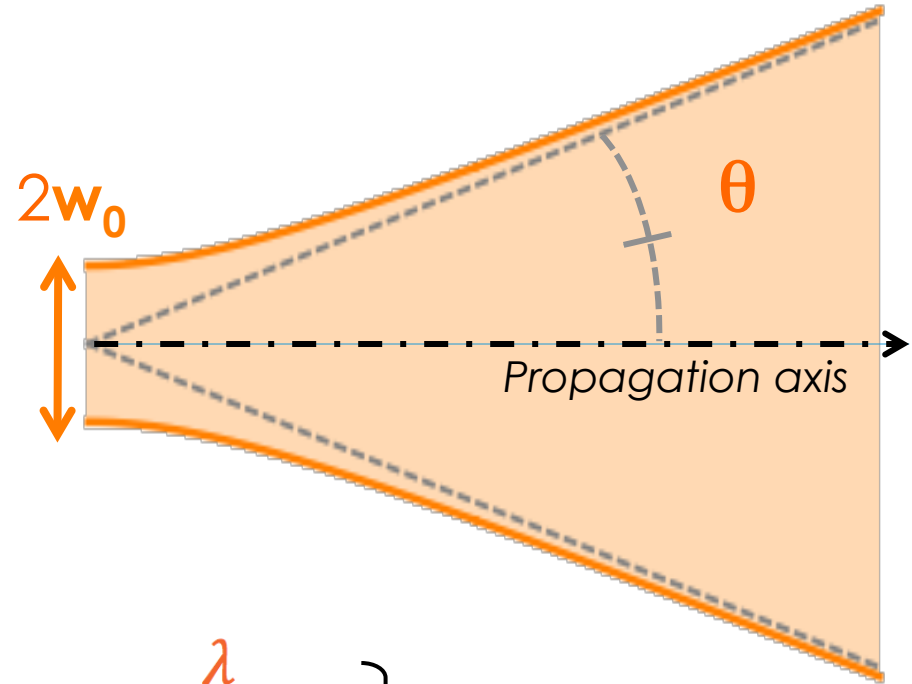
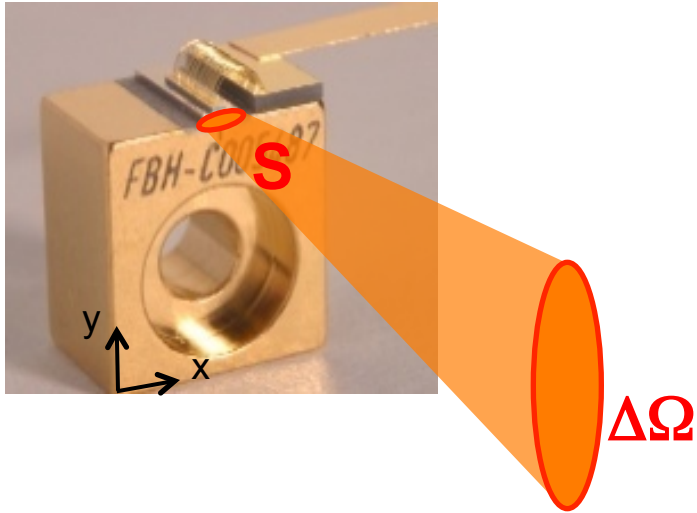

Gaussian diffraction-limited beam : $\theta = \frac{\lambda}{\pi w_0}$

General case : $\theta = M^2 \times \frac{\lambda}{\pi w_0}$

Beam quality parameter

in both x/y axes

Beam parameter product : $BPP = \theta \times w_0 = M^2 \times \frac{\lambda}{\pi} \cong 0.3 \times M^2$ @ $\lambda = 1 \mu\text{m}$

Laser beam propagation : diode lasers

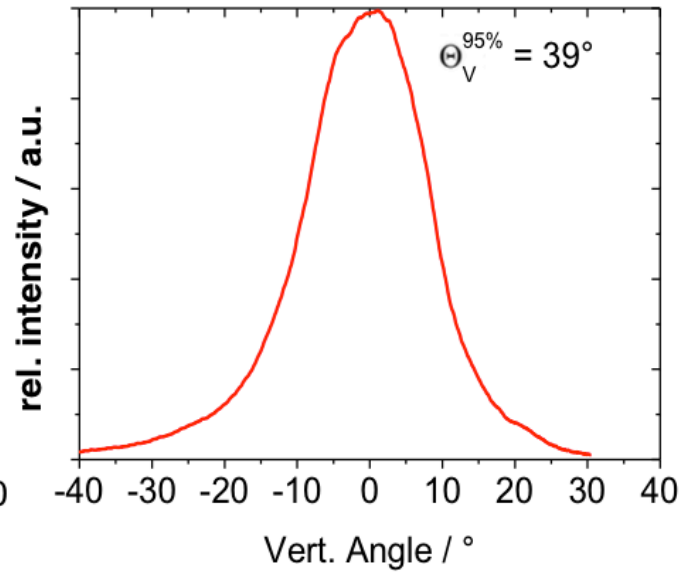
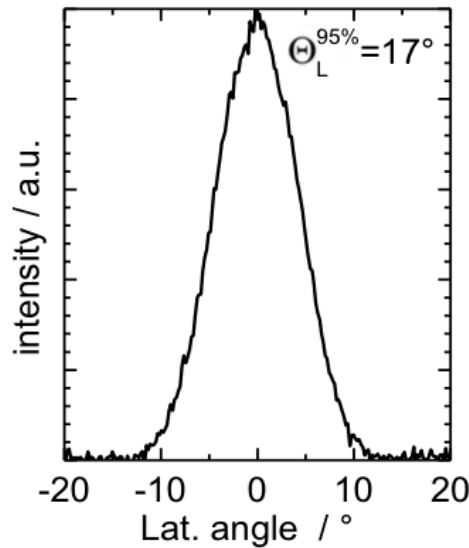
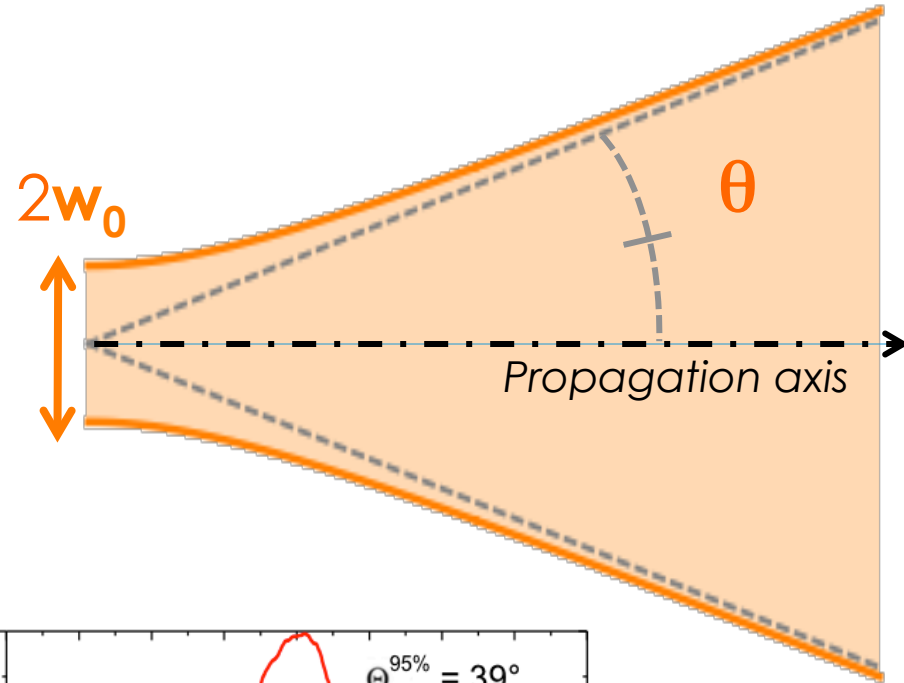
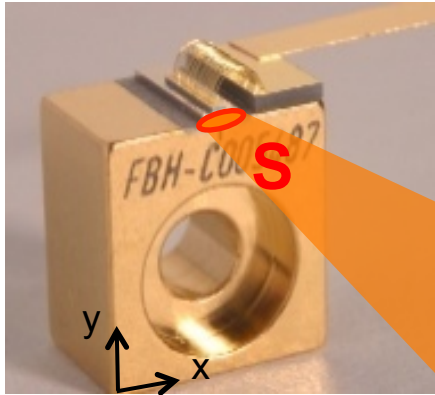

What is the brightness of a laser source ?

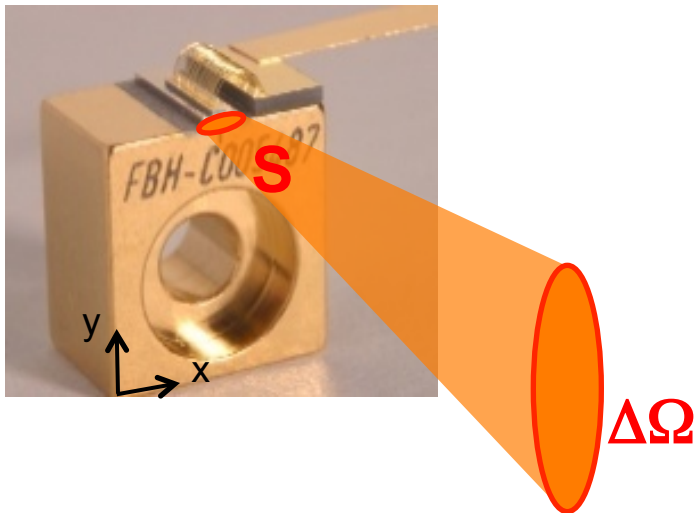

→ The brighter the better ...

Brightness = measurement of the power and beam quality of a laser source

$$B = \frac{P}{S_{em} \times \Delta\Omega} = \frac{P}{\lambda^2 \times M_x^2 M_y^2} \quad [\text{unit : W.m}^{-2}.\text{sr}^{-1}]$$

⇔ ability to focus a high power on a small area with a low NA

What is the brightness of a laser source ?

Brightness = measurement of the power and beam quality of a laser source

$$B = \frac{P}{\lambda^2 \times M_x^2 M_y^2}$$

State-of-the-art	Power	$M_x^2 \times M_y^2$	Brightness
Single-mode LD (a)	1 W	1	100 MW.cm ⁻² .sr ⁻¹
Broad area LD (b)	7 W	1 x 6	110 MW.cm ⁻² .sr ⁻¹
Tapered LD (c)	12 W	1 x 1.2	1000 MW.cm ⁻² .sr ⁻¹

Highest brightness achieved with diffraction-limited laser sources

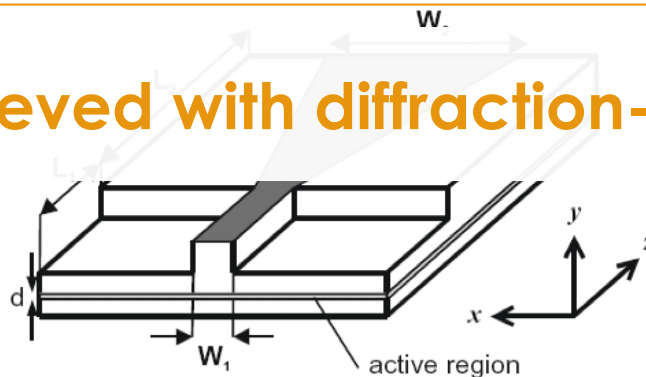

- (a) SCOWL – Donnelly *et al*, IEEE JQE 39, 2 (2003)
 (b) P. Crump, BRIDLE
 (c) Fiebig *et al*. Elec. Lett, 44, p1253 (2008)

- ↗ **output power** of single-mode devices
 - ⇒ increase the power density on facets
 - ⇒ damages & deterioration of lasers

$$B = \frac{P}{\lambda^2 \times M_x^2 M_y^2}$$

- ↗ **output power**
 - ⇒ increase the active volume
 - ⇒ **beam quality** ↘

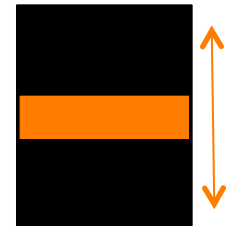

- ↗ **output power** by **combining** parallel laser sources while maintaining the **beam quality**
- = beam combining



- Incoherent (*side-by-side*) combining

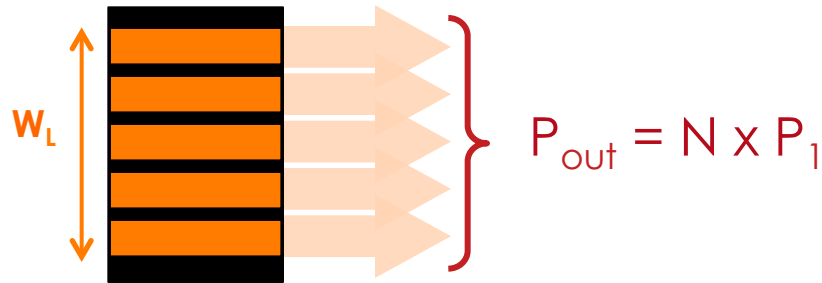

$\nearrow W_L$ but same divergence θ

$$B_{bar} \leq B_1$$

- Spectral beam combining

= superposition of \neq laser lines with grating / dichroïc mirrors / vol Bragg gratings

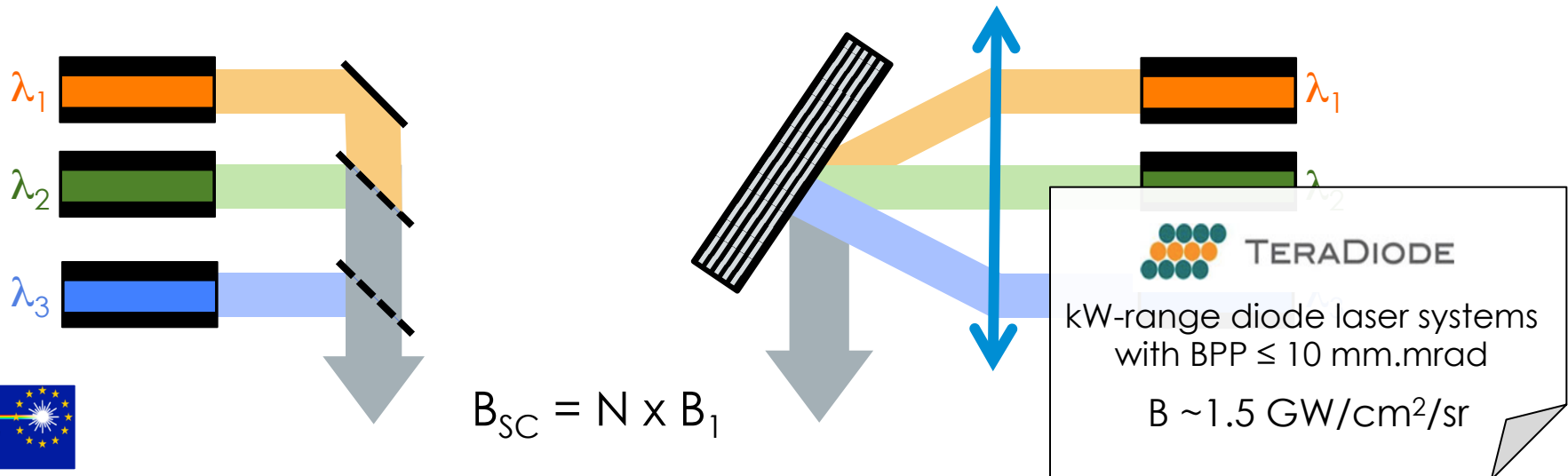

= **constructive superposition** of N laser beams with proper phase relationship

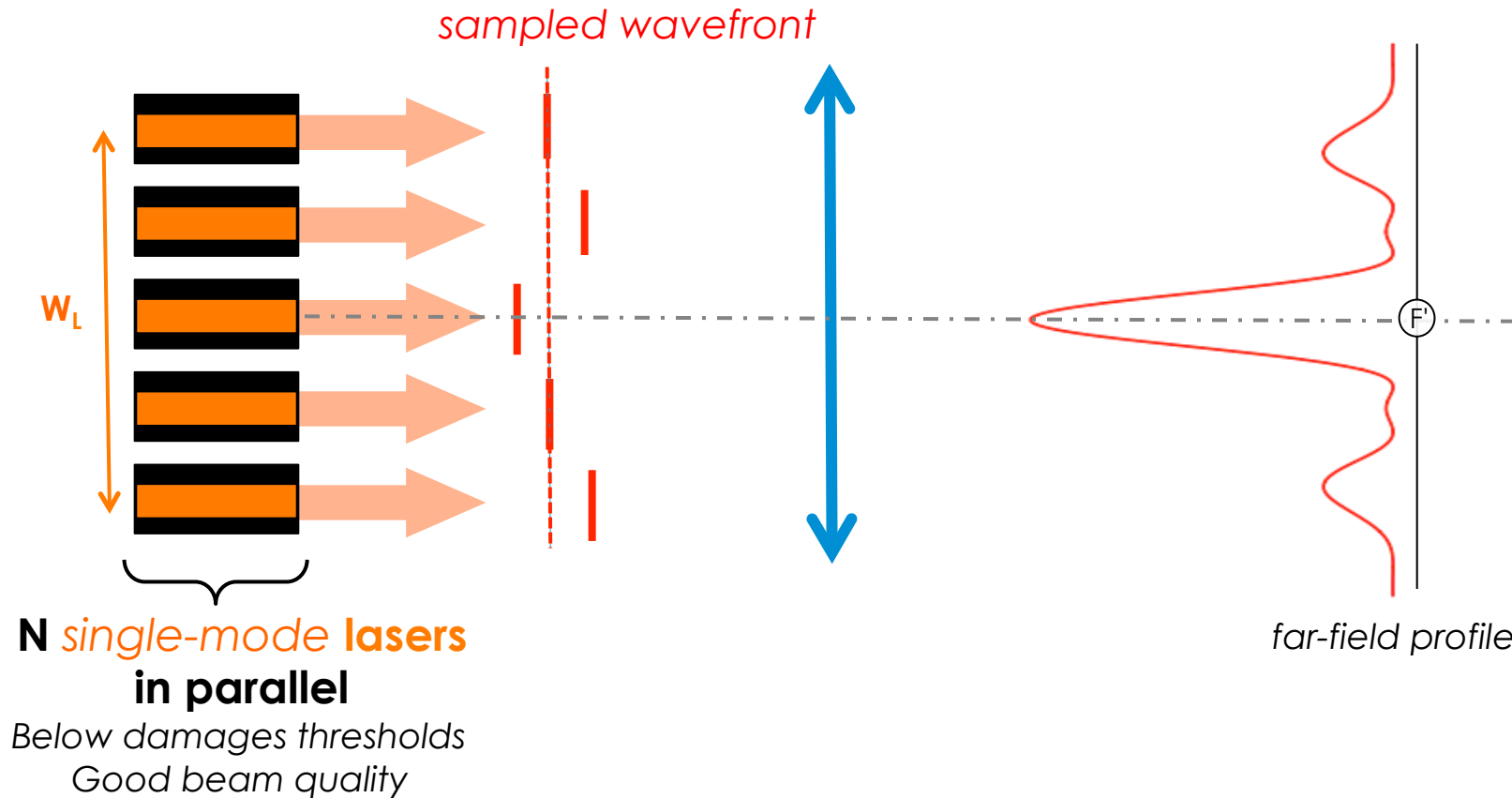

= **constructive superposition** of N laser beams with proper phase relationship

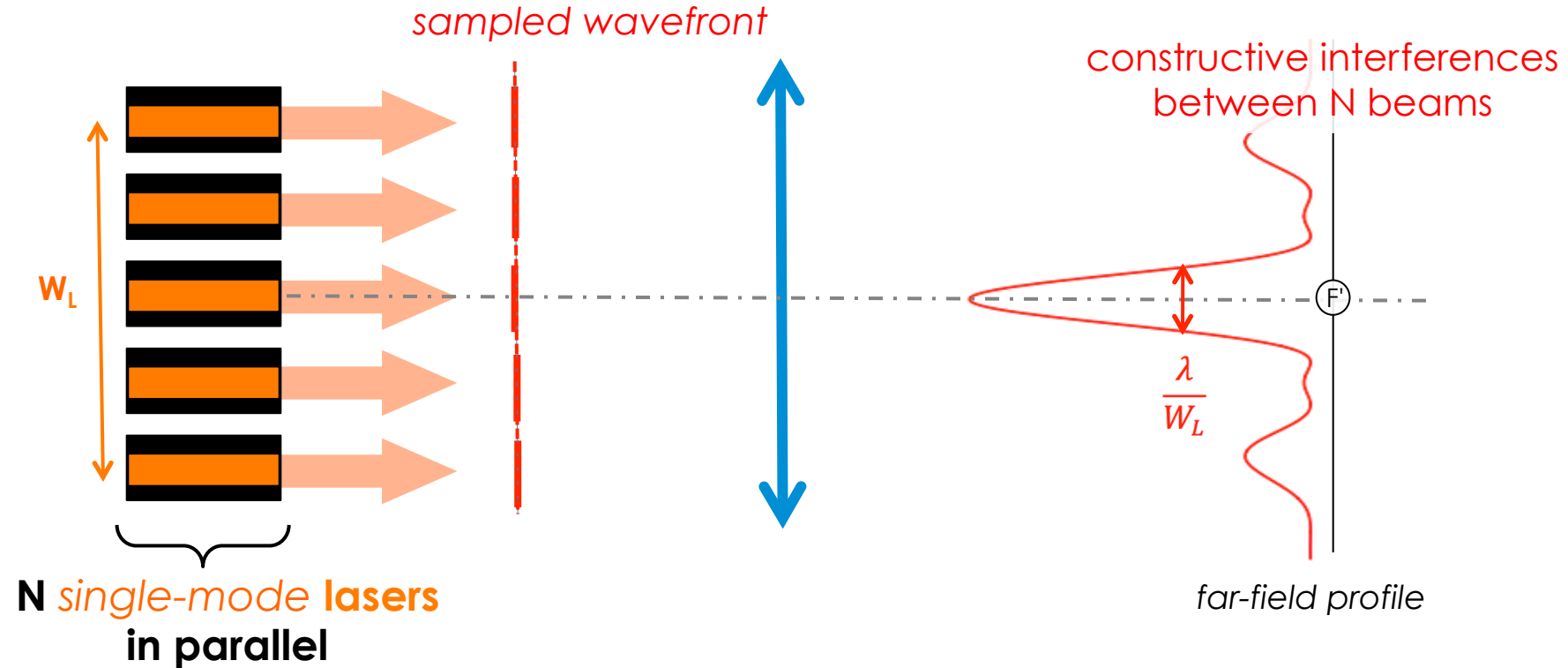

$$B_{CBC} = \frac{N \times P_1}{\lambda^2 \times M_x^2 M_y^2} = N \times B_{single}$$

\nearrow output power
 \nearrow emission width W_L & \searrow divergence θ

} \Rightarrow \nearrow **spatial brightness** + narrow $\Delta\lambda$

= **constructive superposition** of N laser beams with proper phase relationship

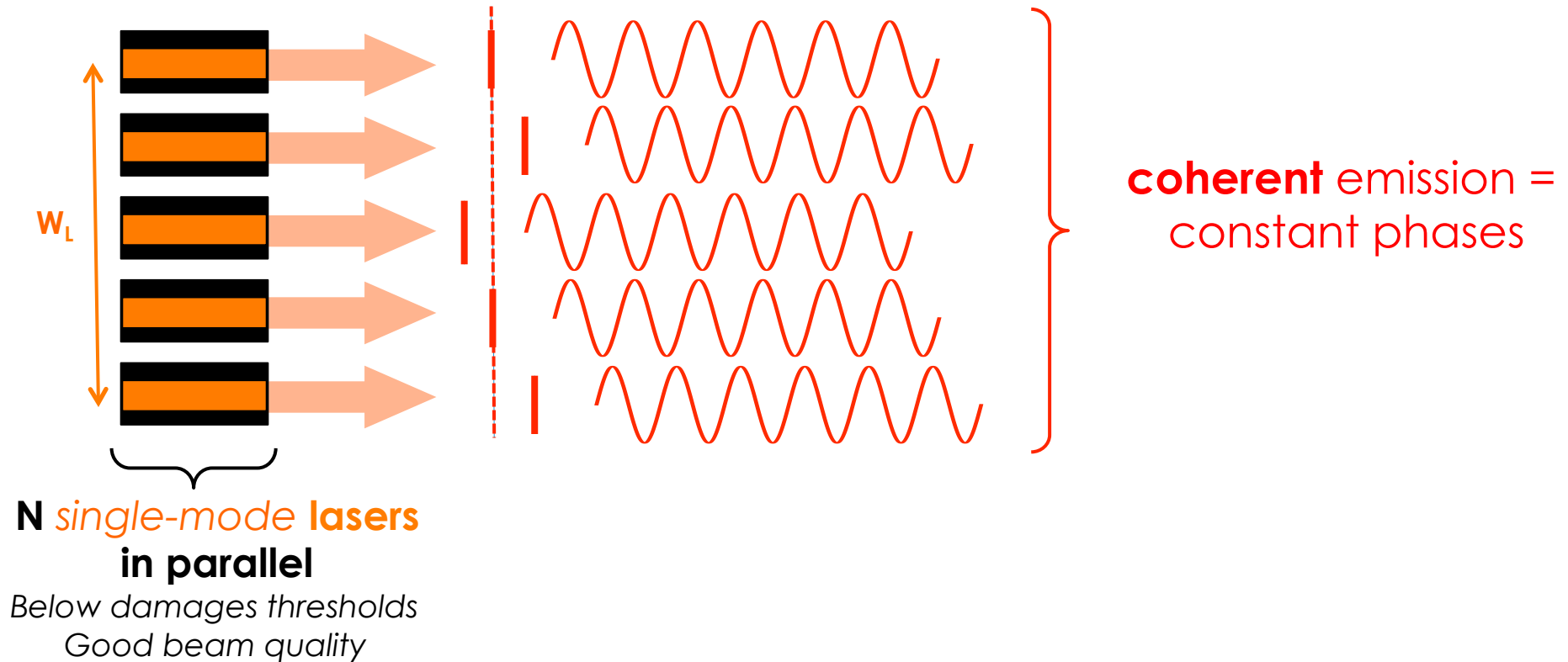

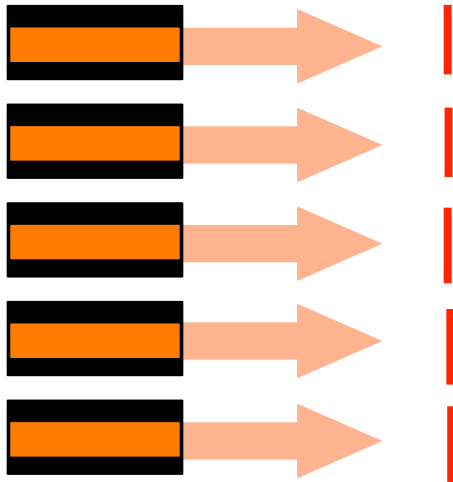

→ MOPA configuration
= **parallel amplification** of one seed
laser in N **amplifiers**

MOPA = Master Oscillator – Power Amplification

→ Self-organizing lasers
= spontaneous operation in the
phase-locked regime of N **lasers**

Demonstration of the amplification of a single-frequency laser beam in a tapered amplifier in a *Mach-Zehnder interferometer* configuration :

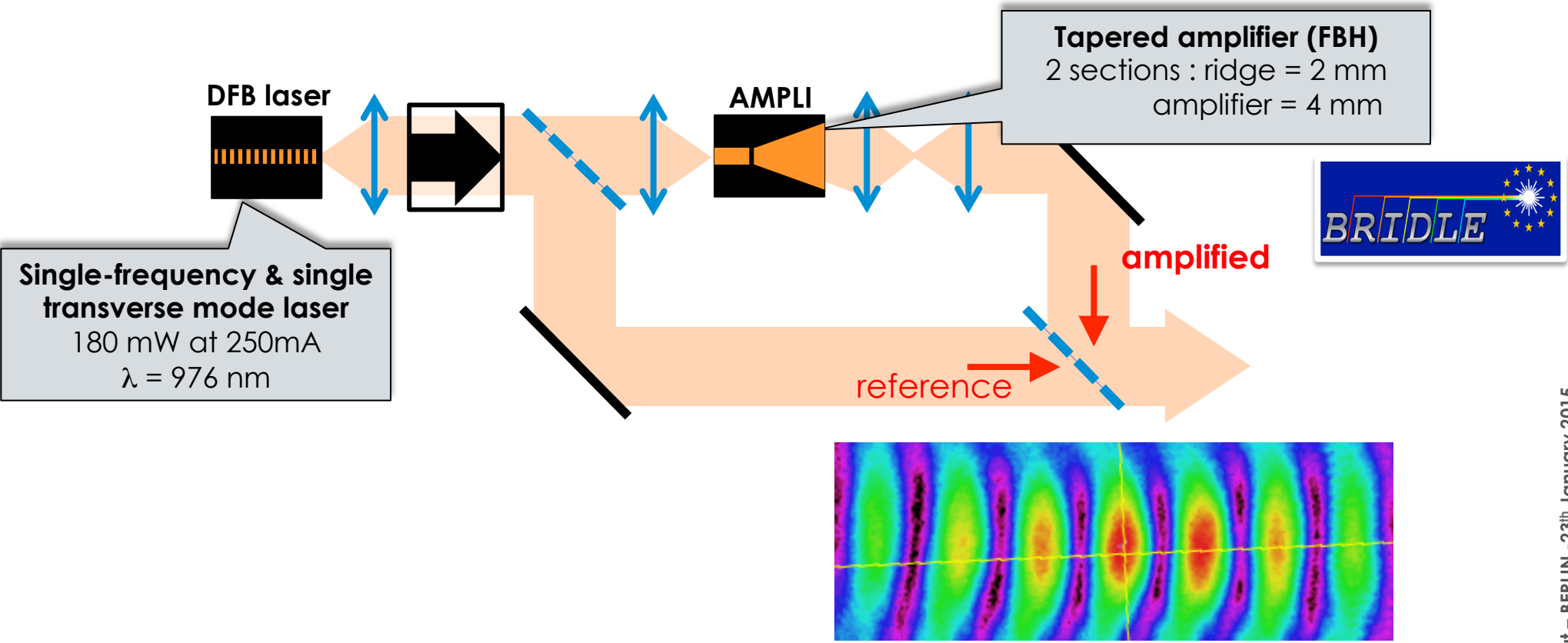

We observe highly-contrasted fringes on the combined port
 ⇒ the seed and amplified beams are phase-locked
 ⇒ the coherence between them is $\geq 96 \%$

Demonstration of the amplification of a single-frequency laser beam in a tapered amplifier in a *Mach-Zehnder interferometer* configuration :

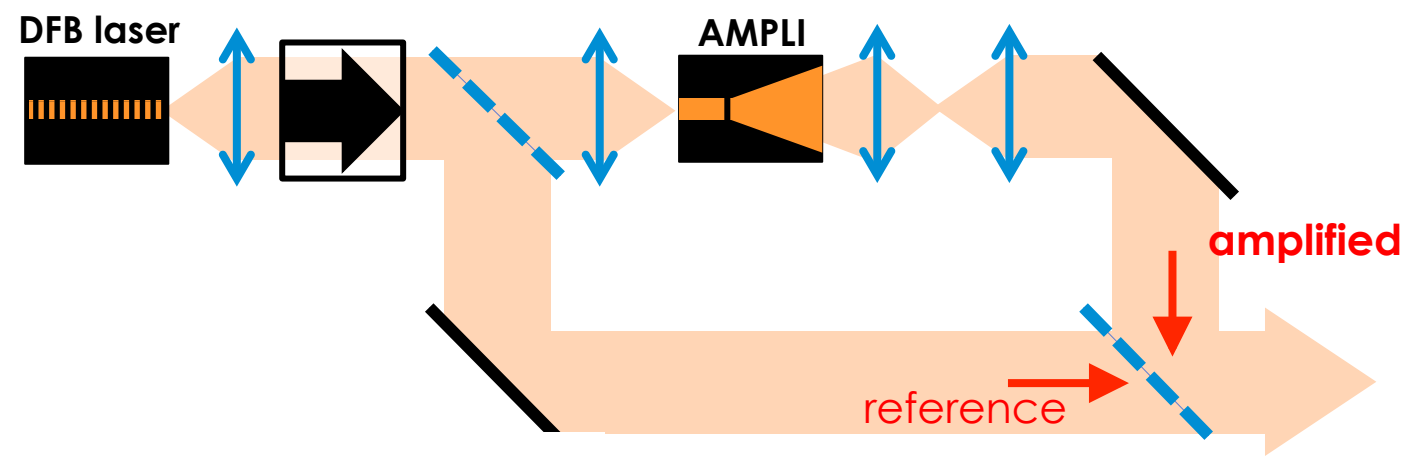

$$\varphi_{AMPLI}(I, T^\circ) = \frac{2\pi}{\lambda} n_{opt} L_{AMPLI}(I, T^\circ)$$

Phase-shift with ridge current

$$\frac{\Delta\varphi_{AMPLI}}{\Delta I_{ridge}} \cong 0.025 - 0.037 \pi/\text{mA}$$

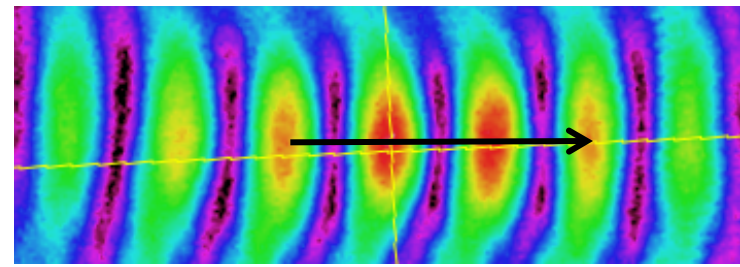

The fringes shift with the currents in the ridge & taper section, because of thermally-induced change of the optical path in the amplifier



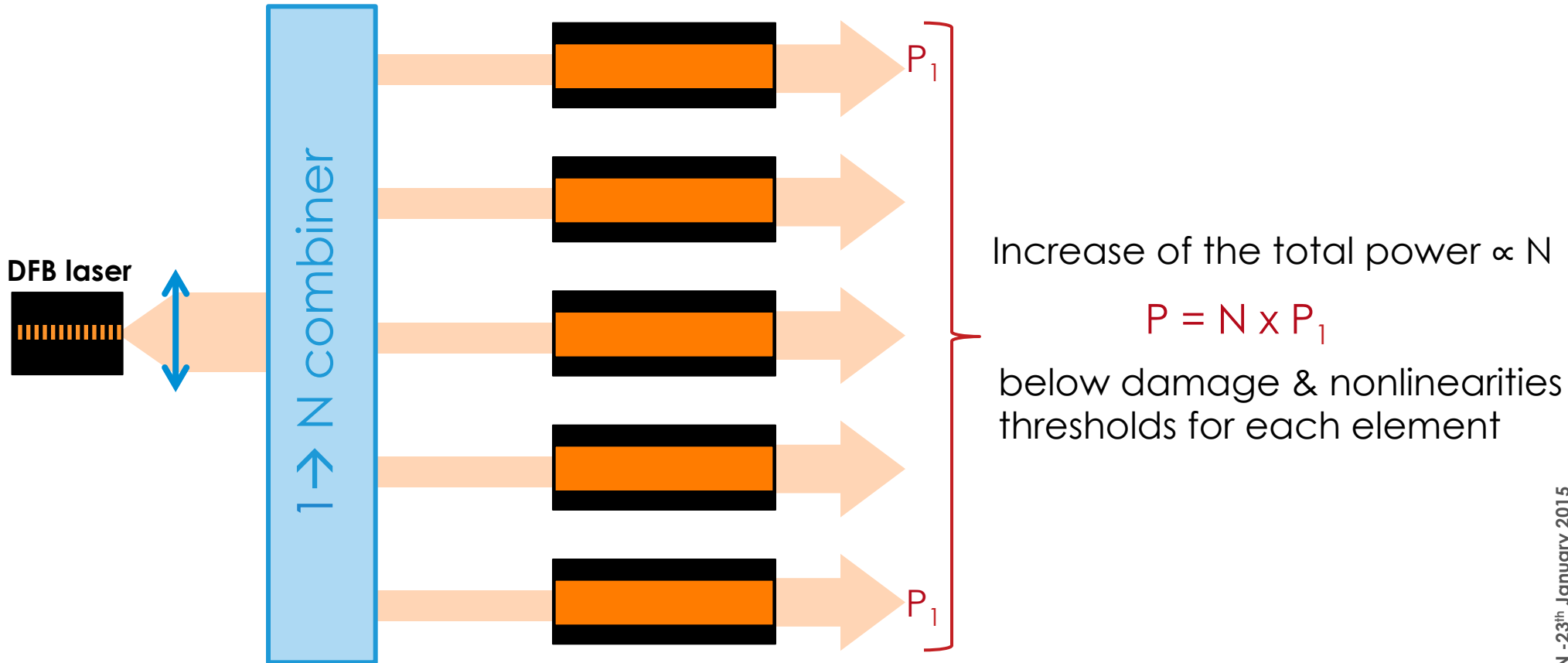

= Amplification of a single-frequency laser beam in multiple amplifiers in //

Phase-locking in a MOPA architecture

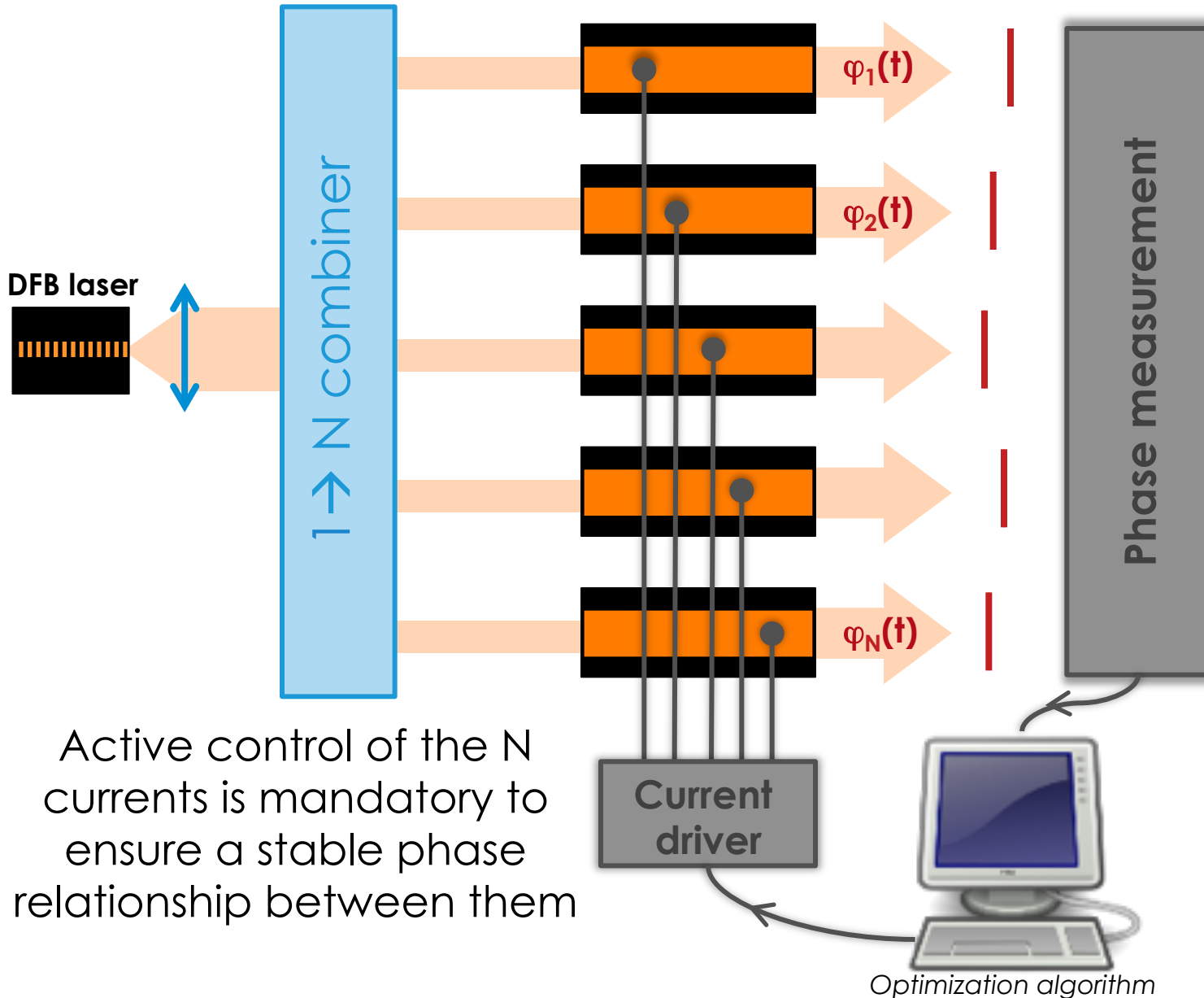

Active phase-locking of a SCOWL array

Single Element
Near Field

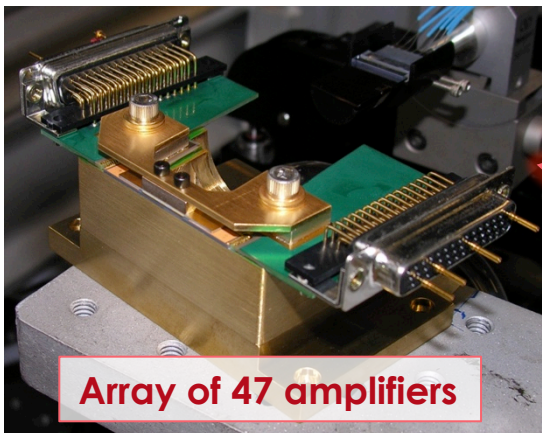
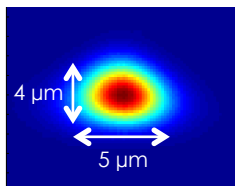

Array of 47 amplifiers

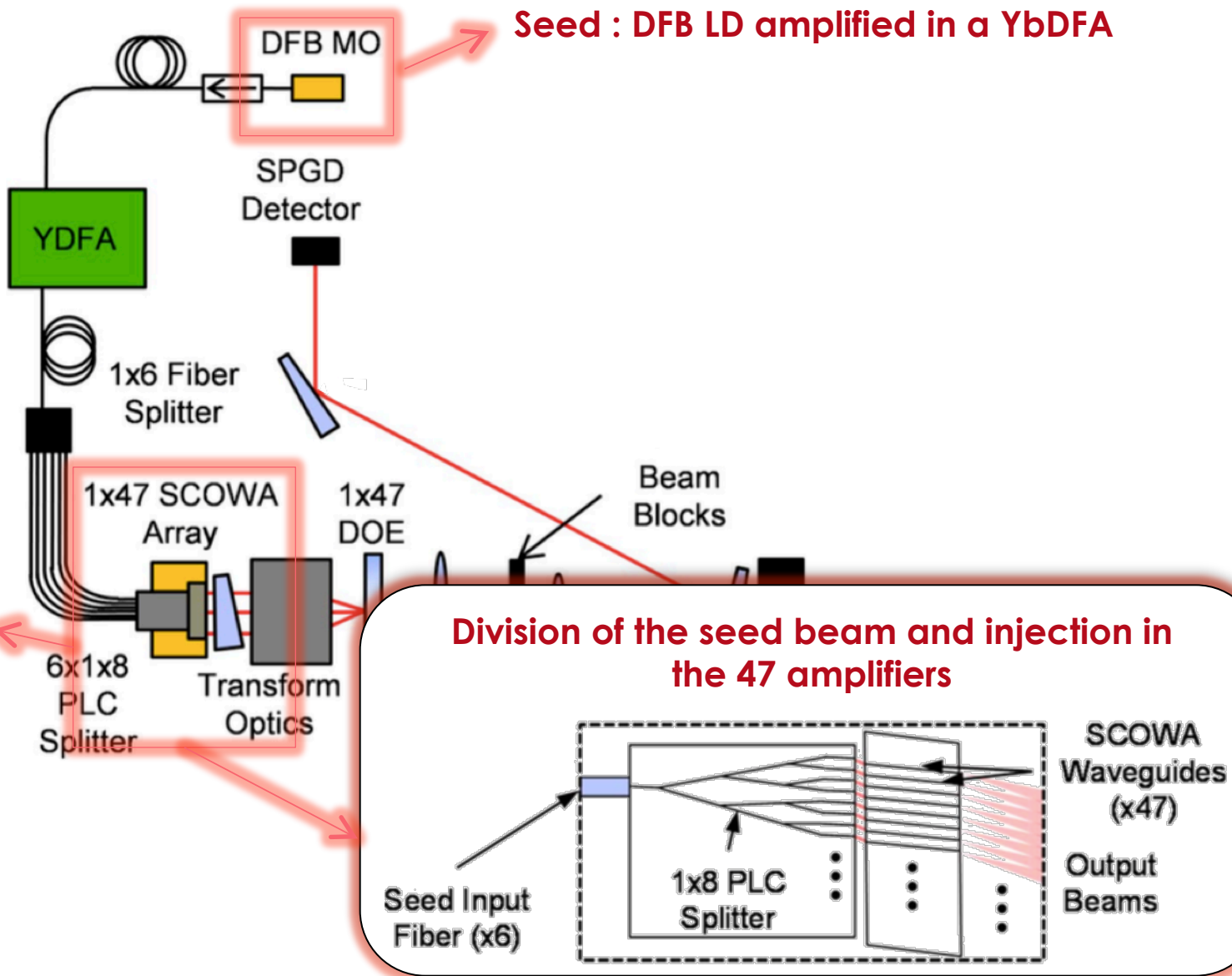

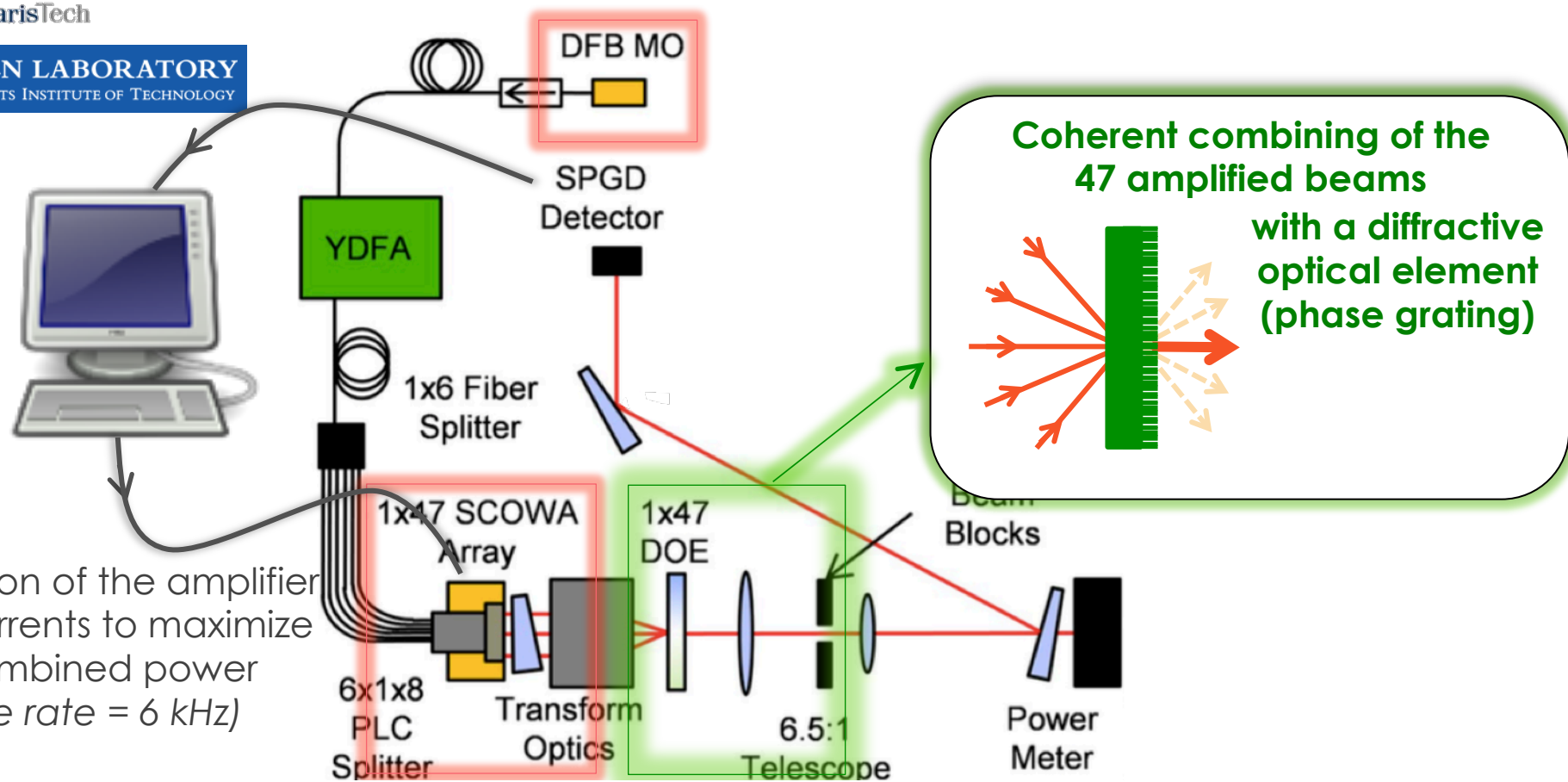

Optimization of the amplifier driving currents to maximize the combined power (update rate = 6 kHz)

→ Demonstration of the **active phase-locking & coherent beam combining** of 47 semiconductor amplifiers

→ **Total output power = 40 W** with $\eta_{\text{CBC}} = 87\%$: $B \sim 2.5 \text{ GW.cm}^{-2}.\text{sr}^{-1}$

$$B_{\text{SC}} = 25 \times B_1$$

5 x 500 W Yb doped fibers amplifiers : **1.93 kW combined**

79 % efficiency, $M^2 = 1.1$

LOCSET active feedback

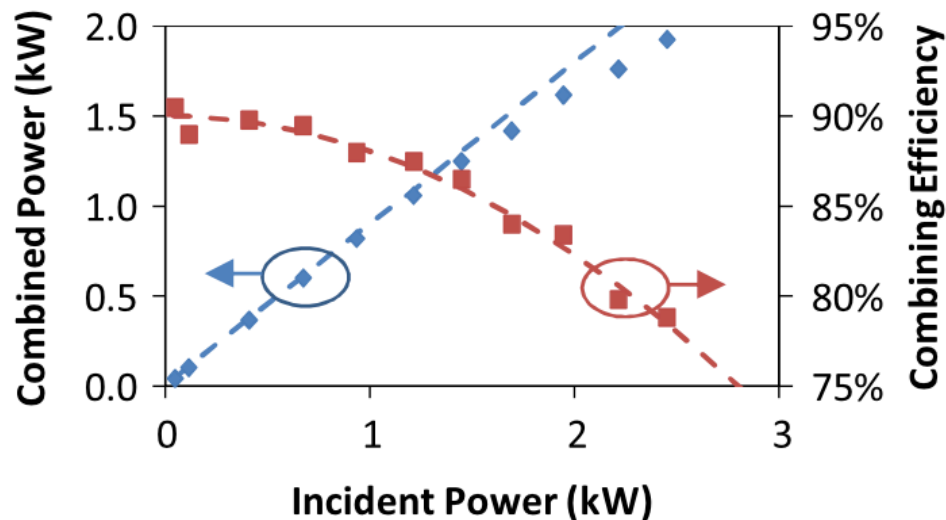
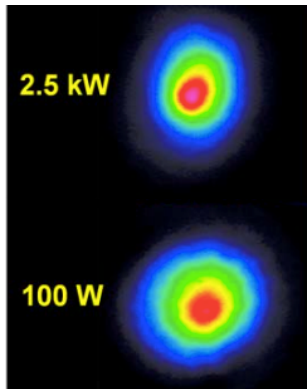
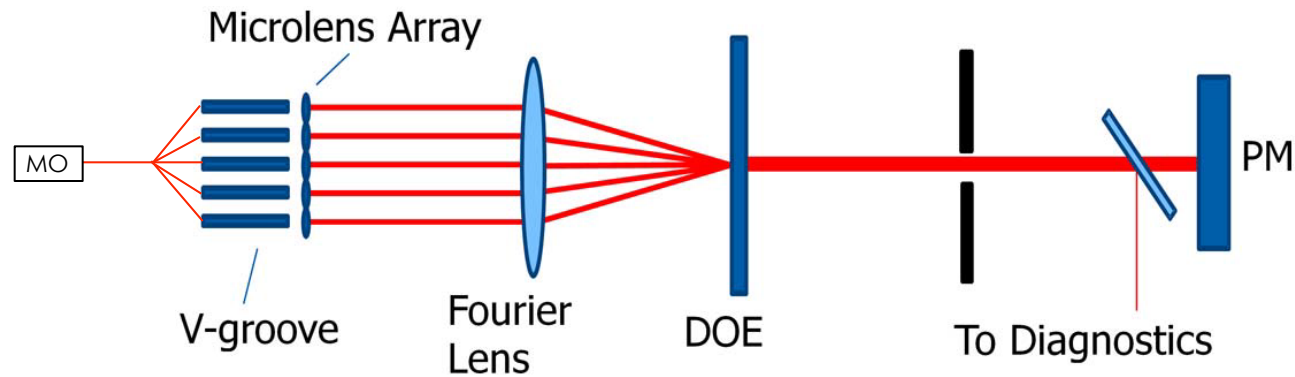

NORTHROP GRUMMAN

Massachusetts
Institute of
Technology

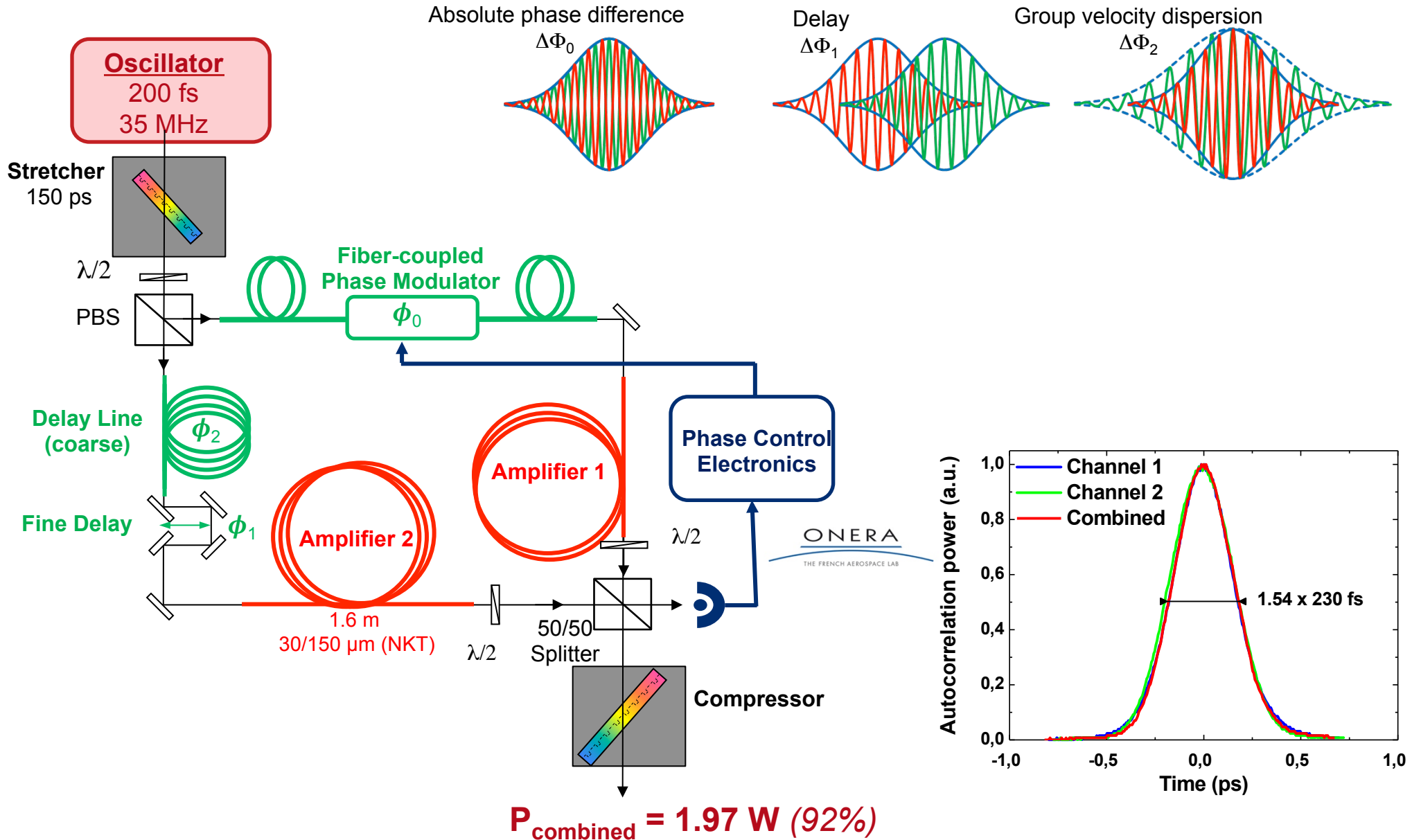

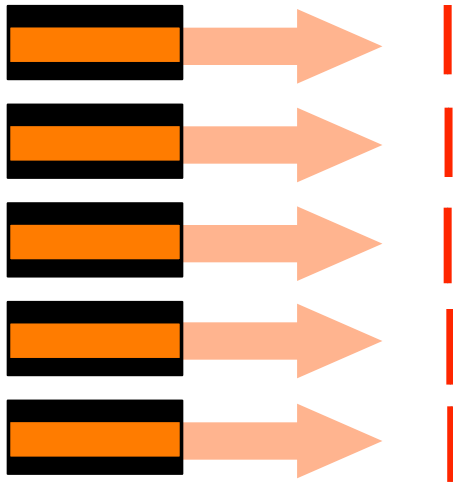

→ MOPA configuration
= **parallel amplification** of one seed laser in N amplifiers

→ Self-organizing lasers
= spontaneous operation in the phase-locked regime of N **lasers**

- phase-locked laser array
evanescent coupling between adjacent emitters

Diode Laser Arrays, ed. Botez & Scifres
(Cambridge Studies in Modern Optics)

- lasers sharing a common external cavity

The external cavity is designed to favour the **collective operation** of the emitters by inducing a **coupling** between them.

⇔ *light from one emitter is reflected into the others*

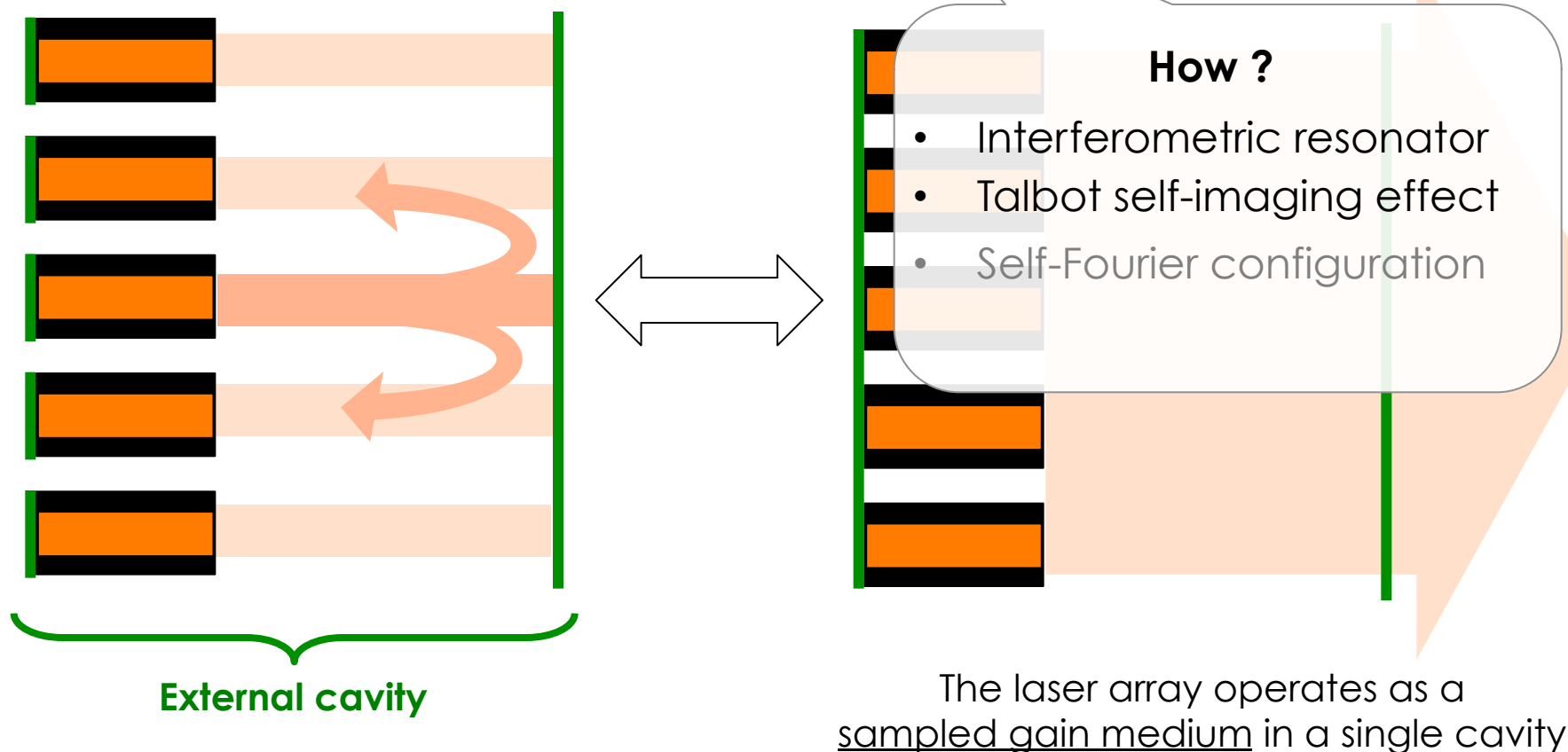

Interferometric resonator = Multi-arm external cavity

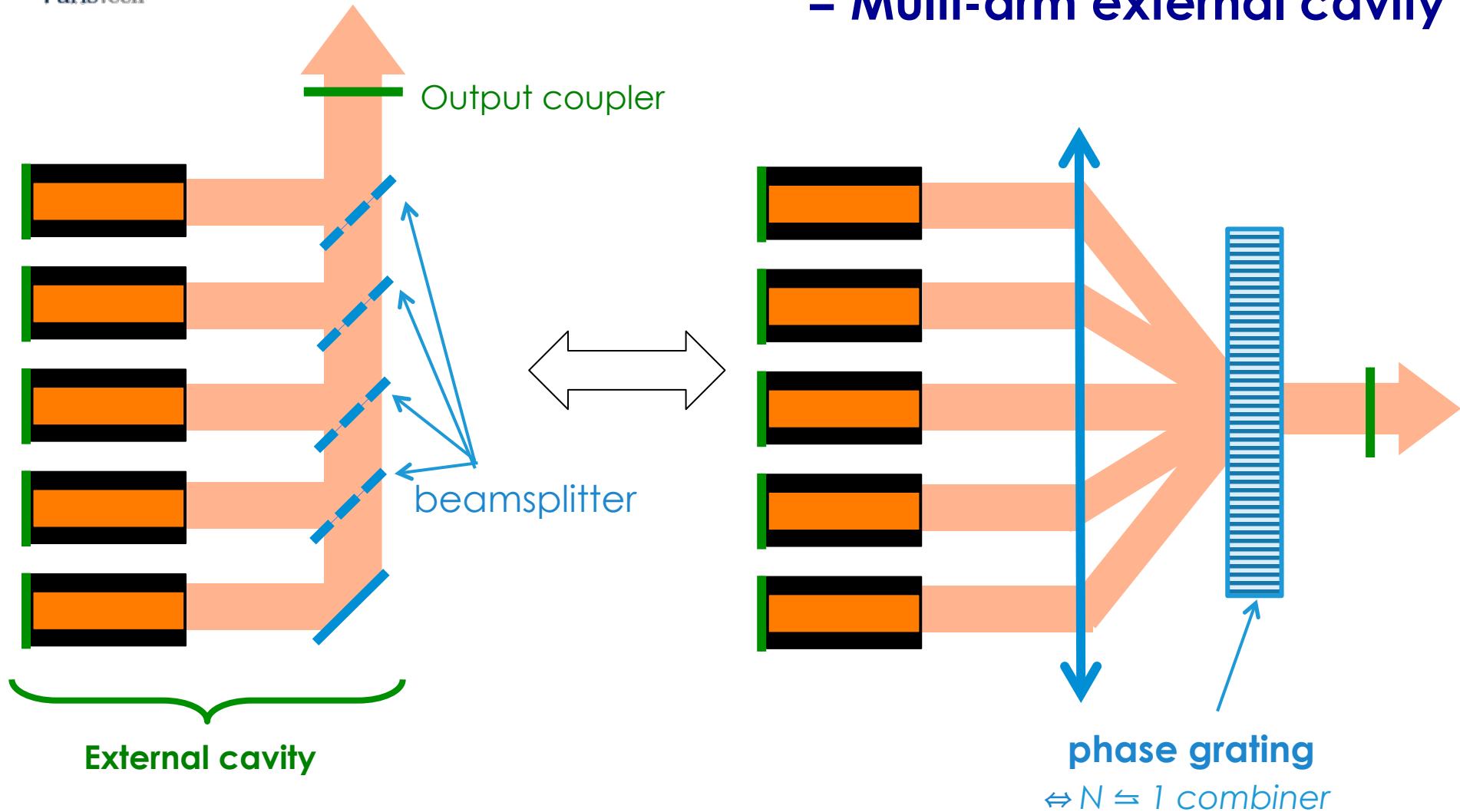

The external cavity favours constructive interferences between the multiple beams.

Michelson cavity : 2-arm interferometer

Minimum losses in the laser cavity for constructive interferences on BS in the P arm : **passive phase-locking** & **coherent combining** of the two lasers

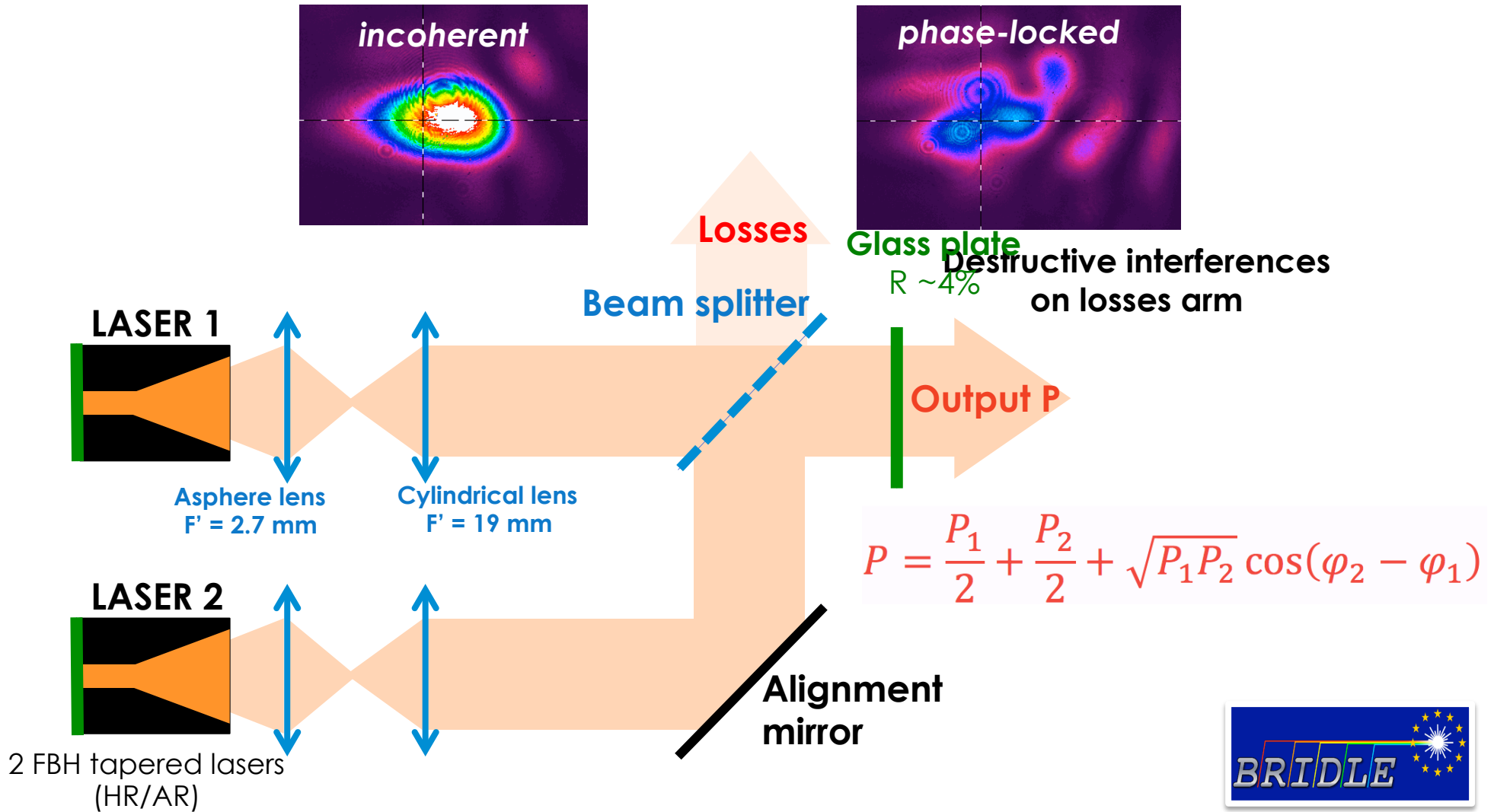

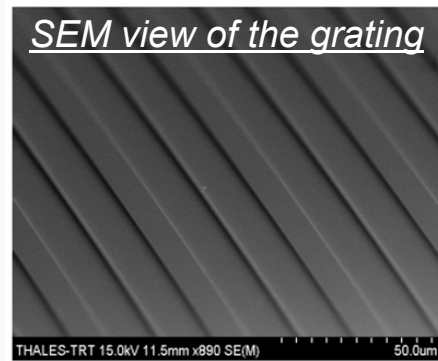
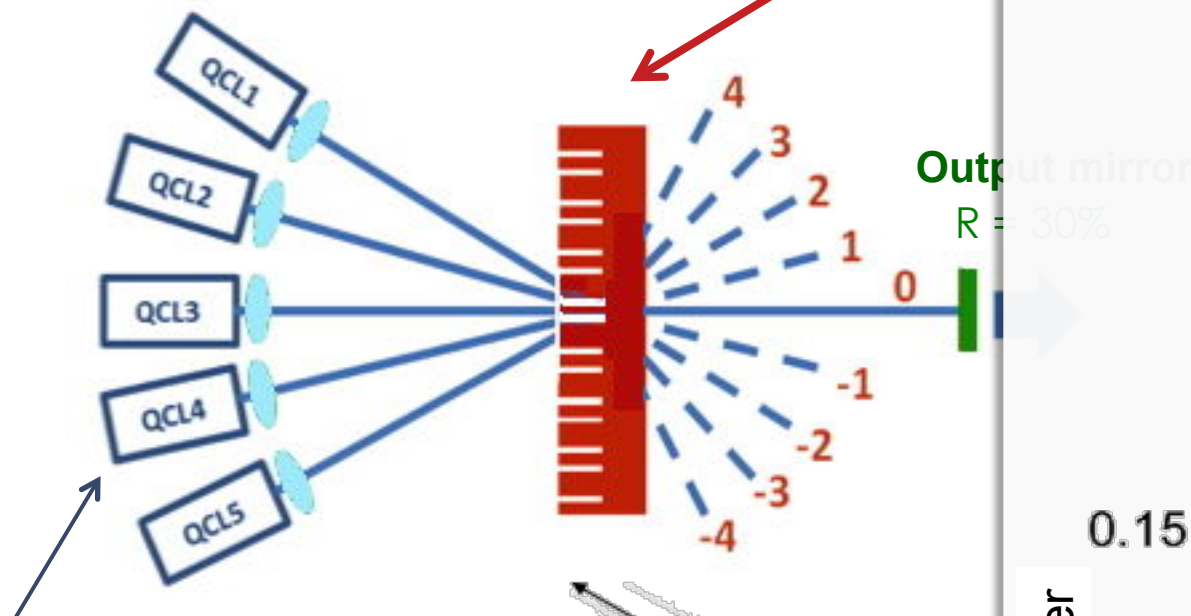

Binary phase grating ($0 - \pi$)
 $1 \cong 5$ combiner at $\lambda = 4.65 \mu\text{m}$
 Pitch $\Lambda = 50 \mu\text{m}$

Quantum Cascade Lasers

$\lambda = 4.6 \mu\text{m}$

GalnAs/AlInAs active regions
 HR / AR (<2%)

$M^2_y \leq 1.2, M^2_z \leq 1.5$

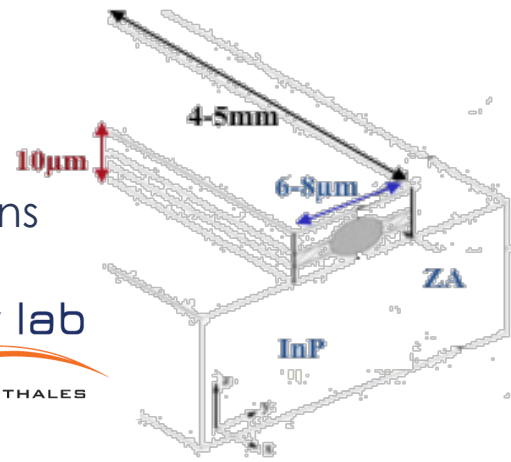

Phase grating

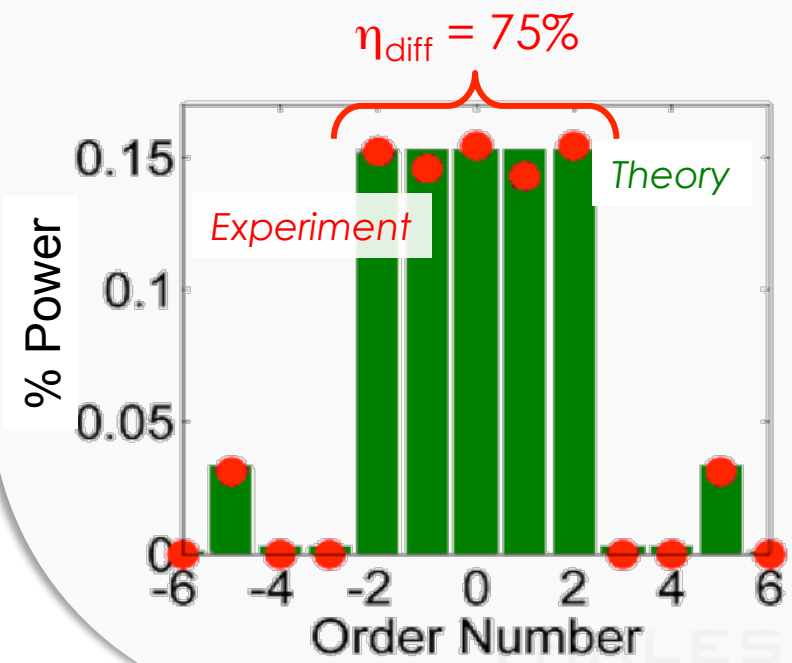

Minimum losses in the laser cavity for constructive interferences in the 0th order of the PG : **passive phase-locking & coherent combining**

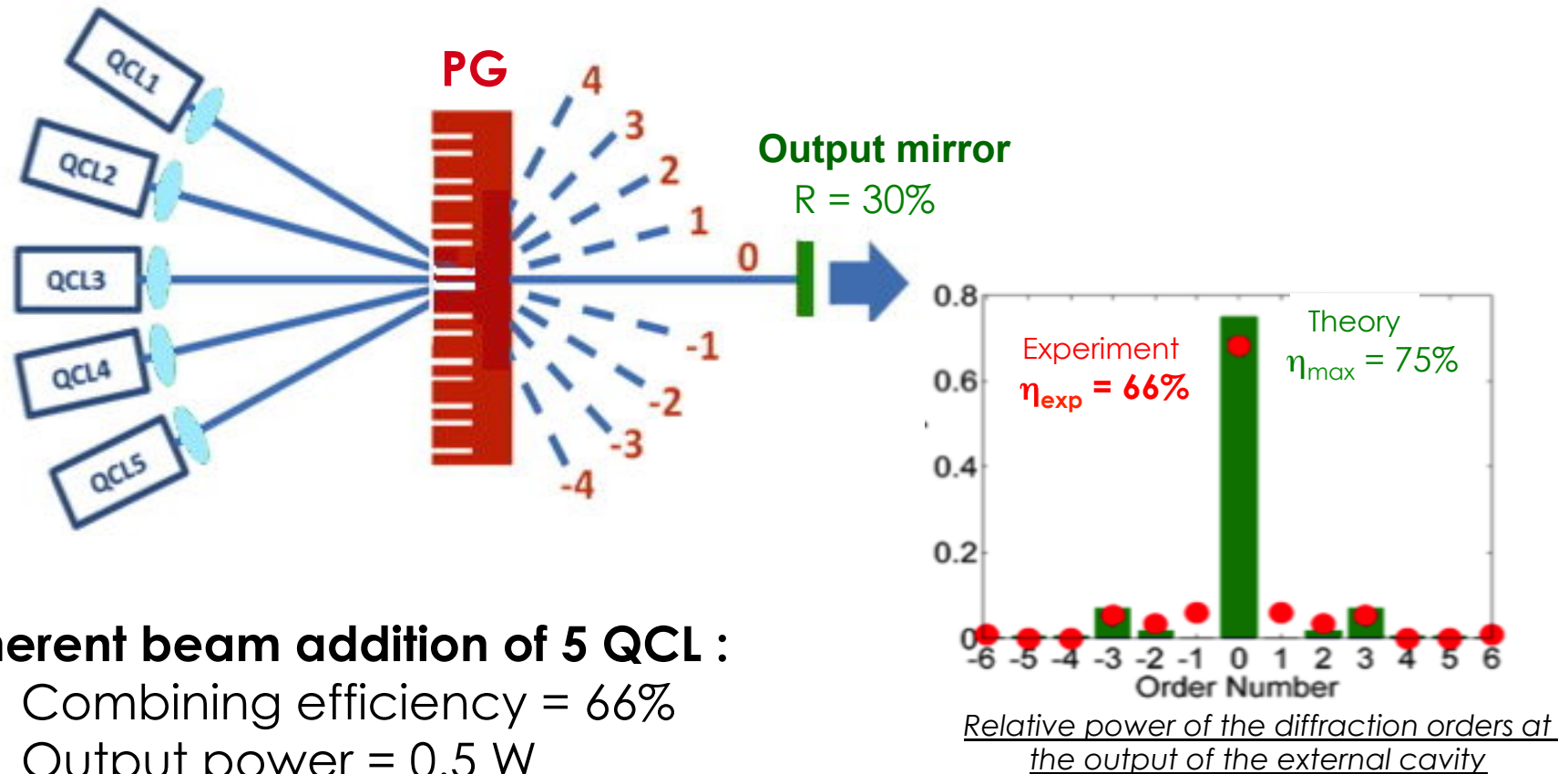

→ **Coherent beam addition of 5 QCL :**
 Combining efficiency = 66%
 Output power = 0.5 W
 Diffraction-limited beam ($M^2 < 1.6$)

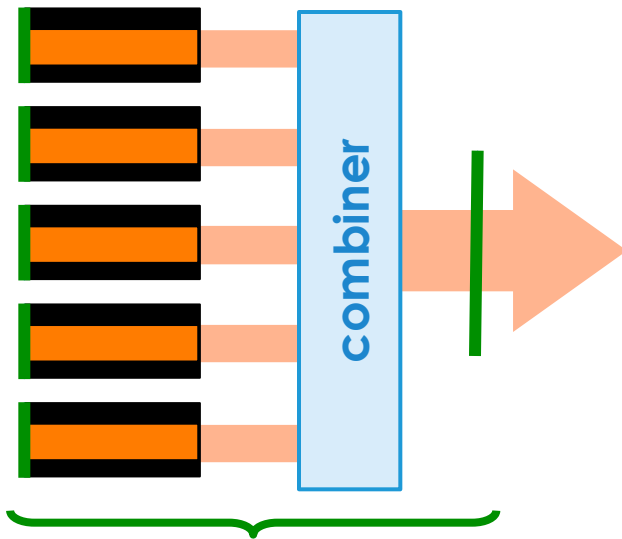

→ MOPA configuration
= **parallel amplification** of one seed laser in N amplifiers

→ Self-organizing lasers
= spontaneous operation in the phase-locked regime of N **lasers**

- lasers in a **common external cavity**

Interferometric resonator
⇒ *filled aperture*

Self-imaging cavity : Talbot effect
⇒ *tiled aperture*

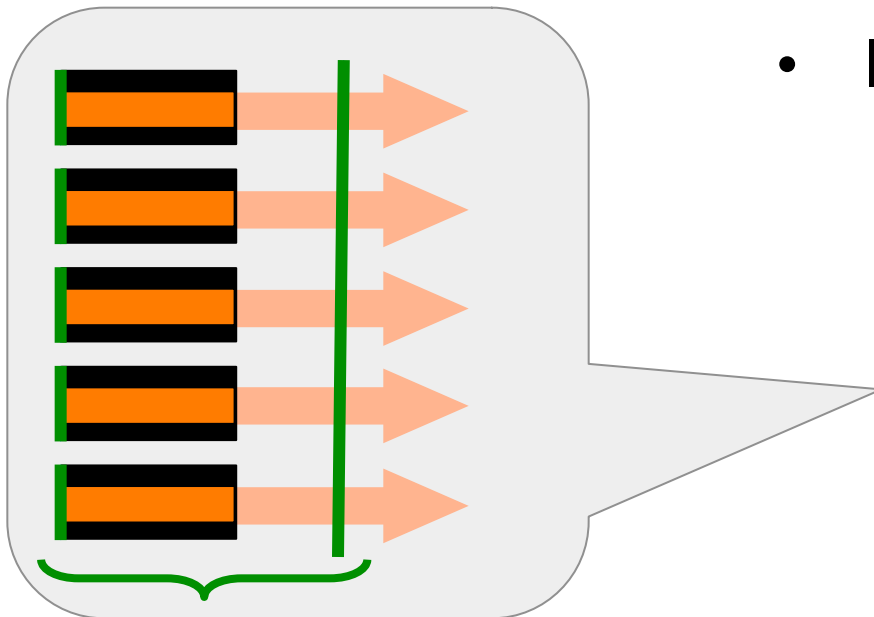

Near-field diffraction effect observed for a grating illuminated by monochromatic light :

→ self-images (E, φ) at multiples of $\frac{Z_T}{2} = \frac{p^2}{\lambda}$

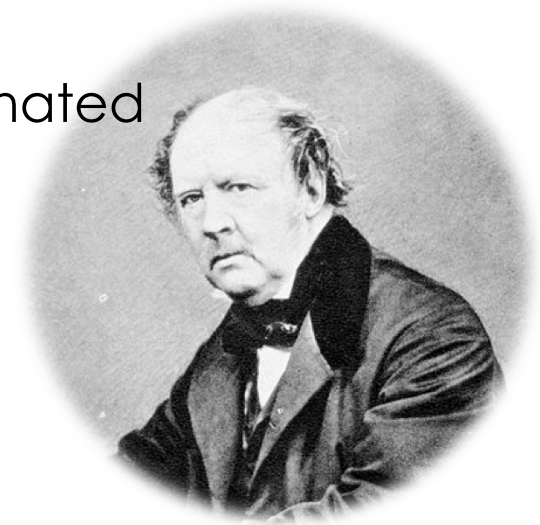
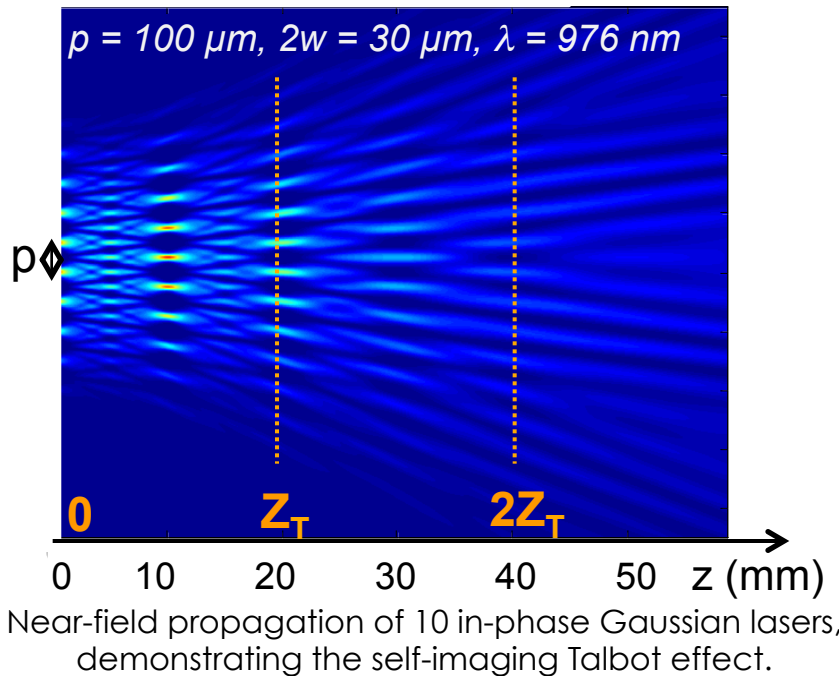

W. H. F. Talbot
"Facts relating to optical science"
Philos. Mag. 9 (1836)

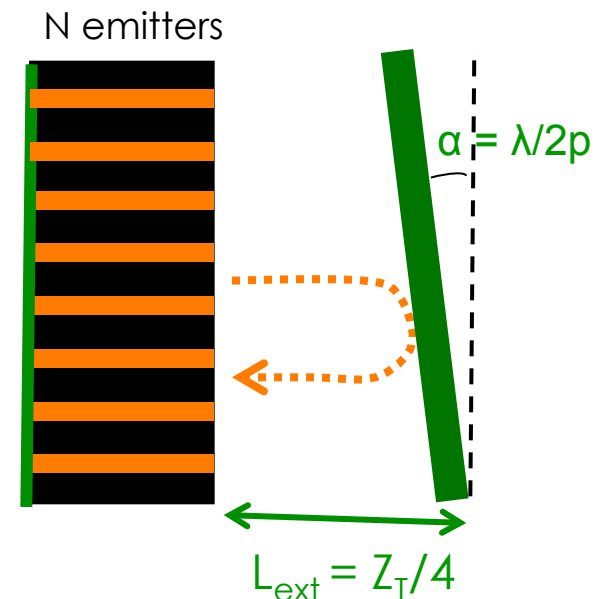

⇒ effect used in an external cavity to maximize the coupling between emitters :
maximum back reflection of light for $L_{\text{ext}} = Z_T/4$

Passive phase-locking in a Talbot cavity

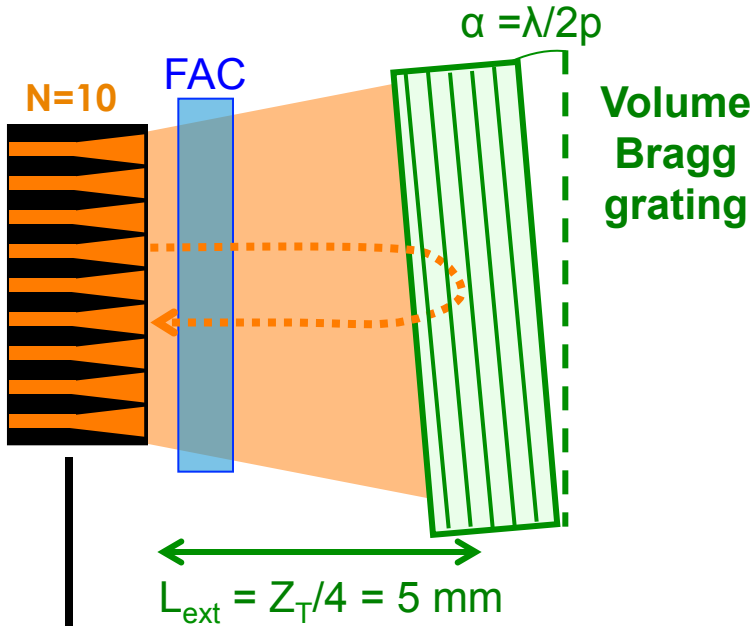

→ Output coupler with angular + spectral selectivity

$R_B \cong 40 \%$
 $\lambda_B = 975.4 \text{ nm}, \Delta\lambda = 0.3 \text{ nm}$
 $\Delta\theta = 2^\circ \text{ (FWHM)}$

Array of 10 index-guided tapered emitters
 pitch = 100 μm , 0.4W/emitter

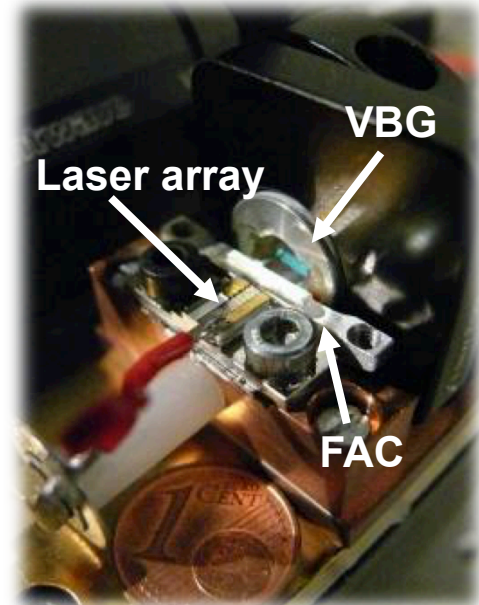

Experimental setup

Evaluation of the coherence of the array

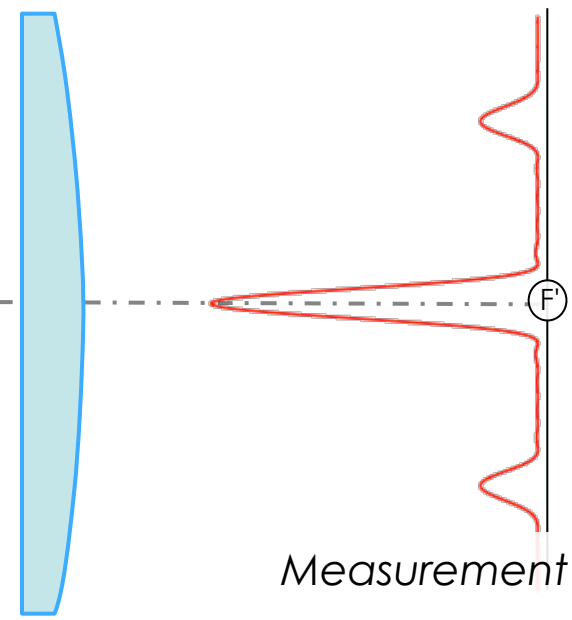
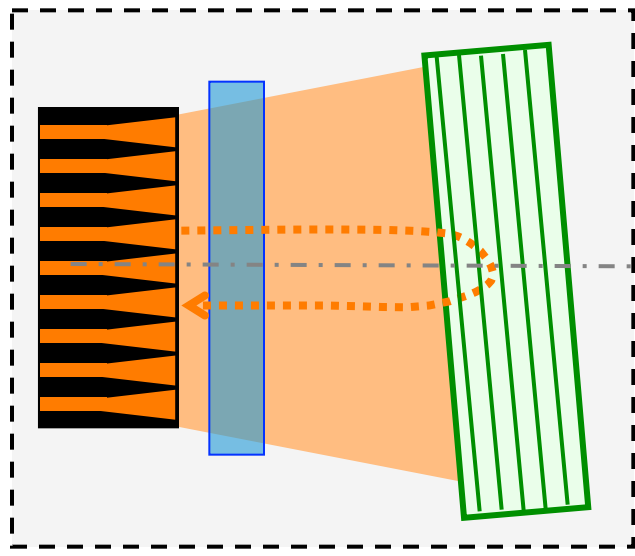

Measurement of the far-field profile

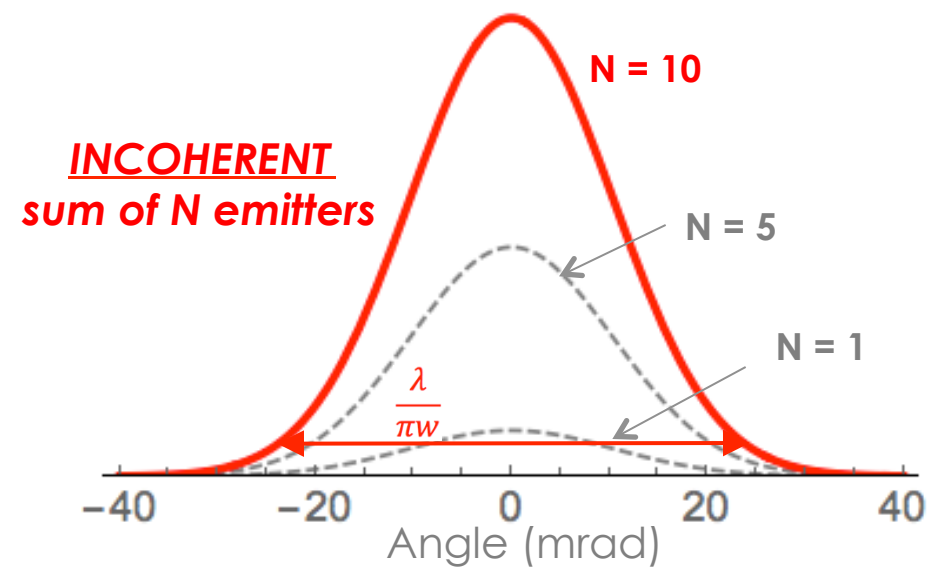

Evaluation of the coherence of the array

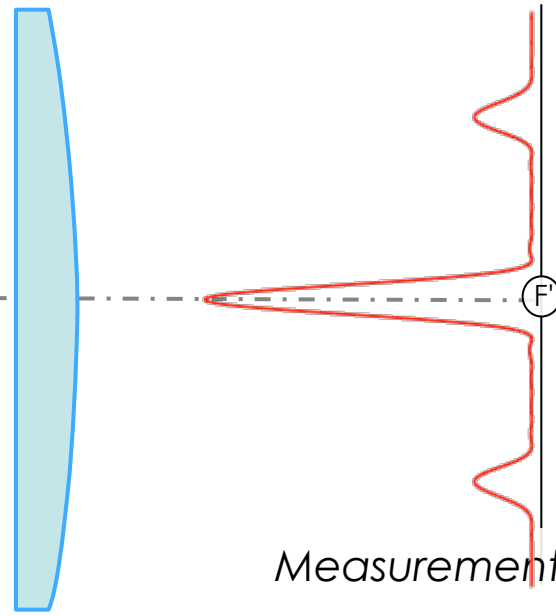
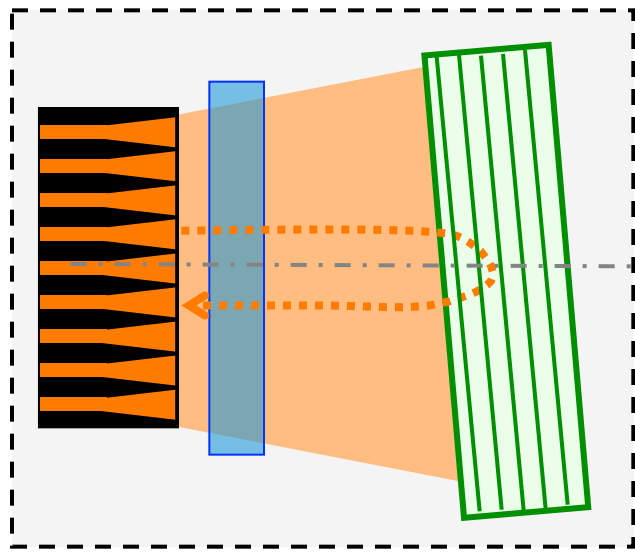

Measurement of the far-field profile

N = 2 in-phase emitters

COHERENT
sum of N emitters

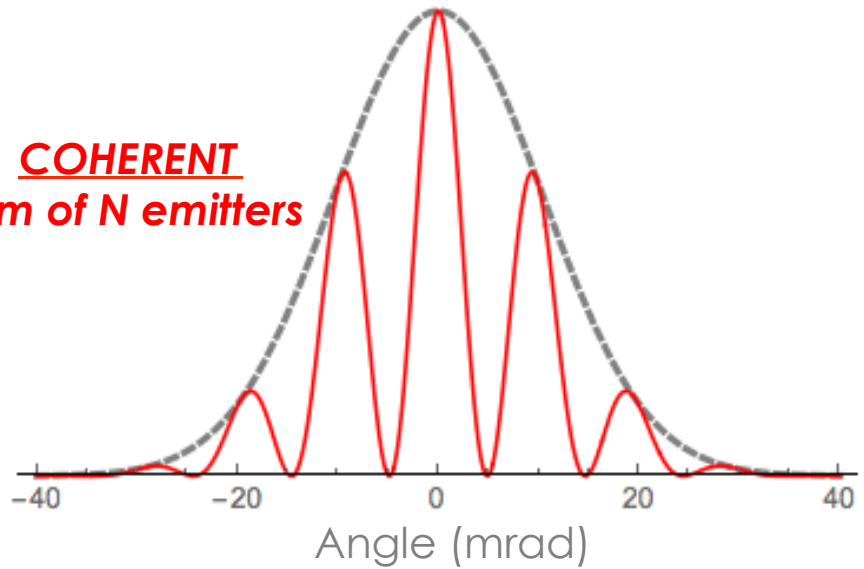

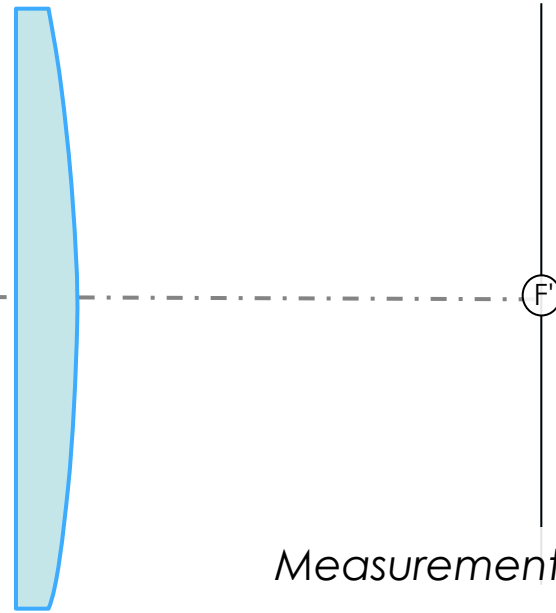
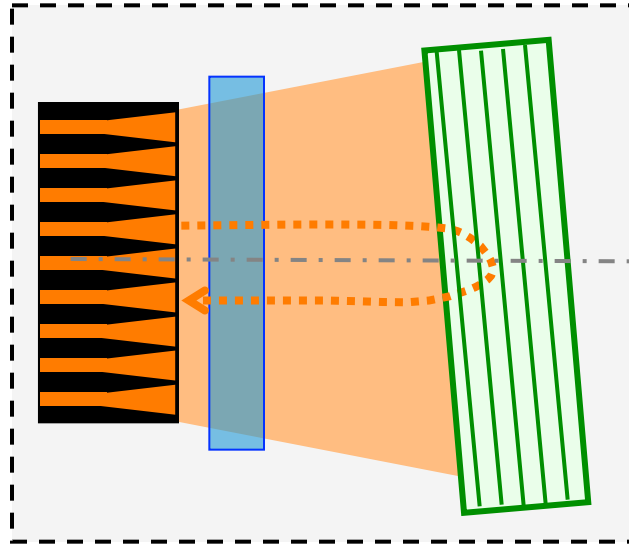

Measurement of the far-field profile

N = 10 in-phase emitters

**COHERENT
sum of N emitters**

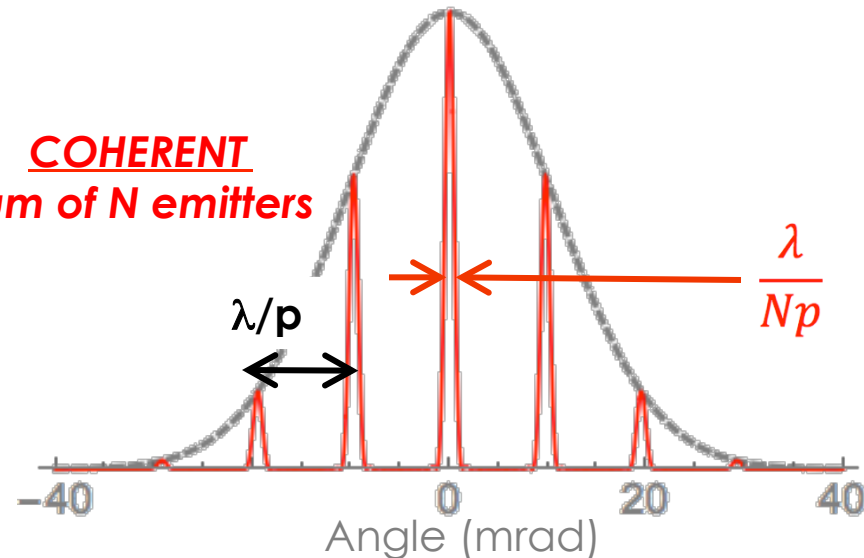

→ Coherent operation is evidenced by
regularly spaced
& narrow peaks
in the FF profile

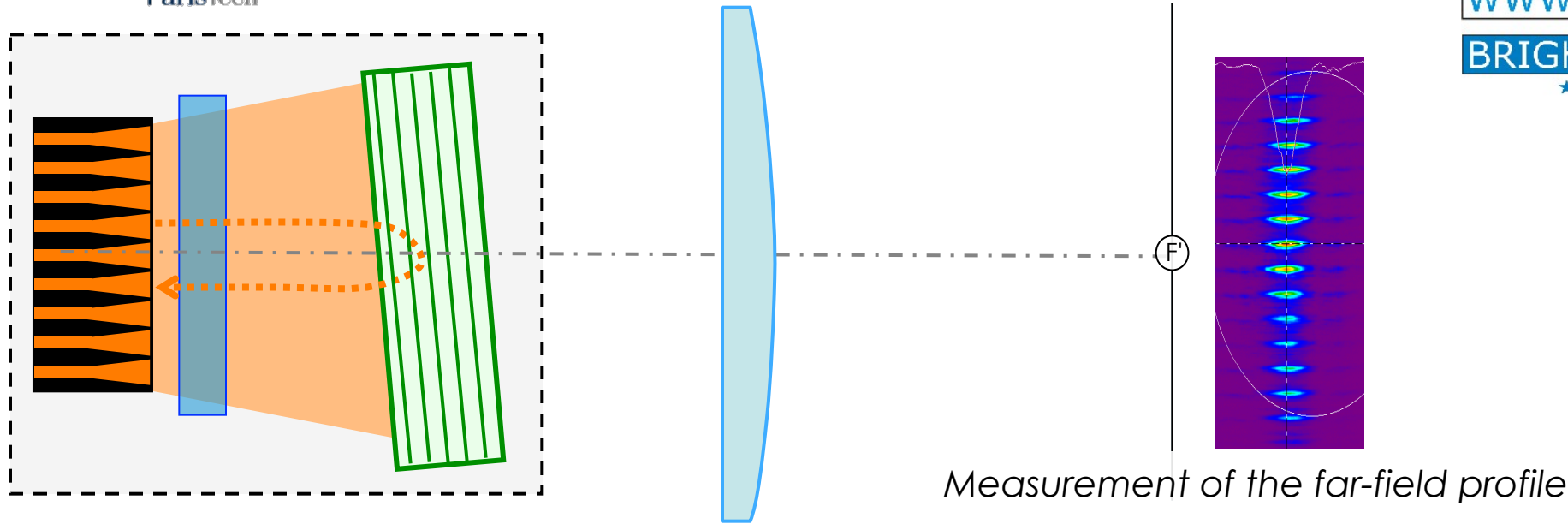

Measurement of the far-field profile

Spectral locking of each laser diodes
Narrow linewidth ($\Delta\lambda < 0.1 \text{ nm}$)

Laser threshold $I_{th} = 0.9 \text{ A}$
 $P_{max} = 1.7 \text{ W} @ 4 \text{ A} (4 \times I_{th})$

Operation in the in-phase mode
Highly-contrasted fringes in the FF
 $V \geq 80\%$

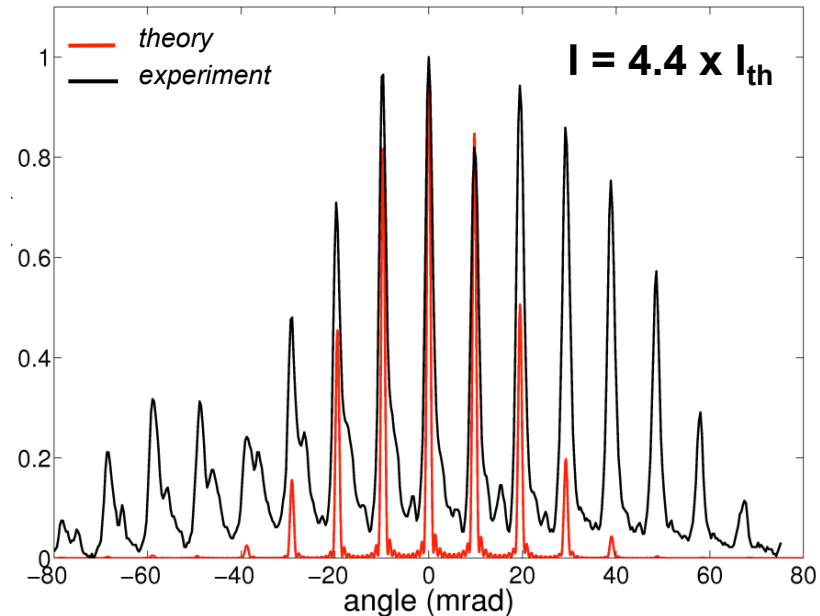

Near-field conversion setup

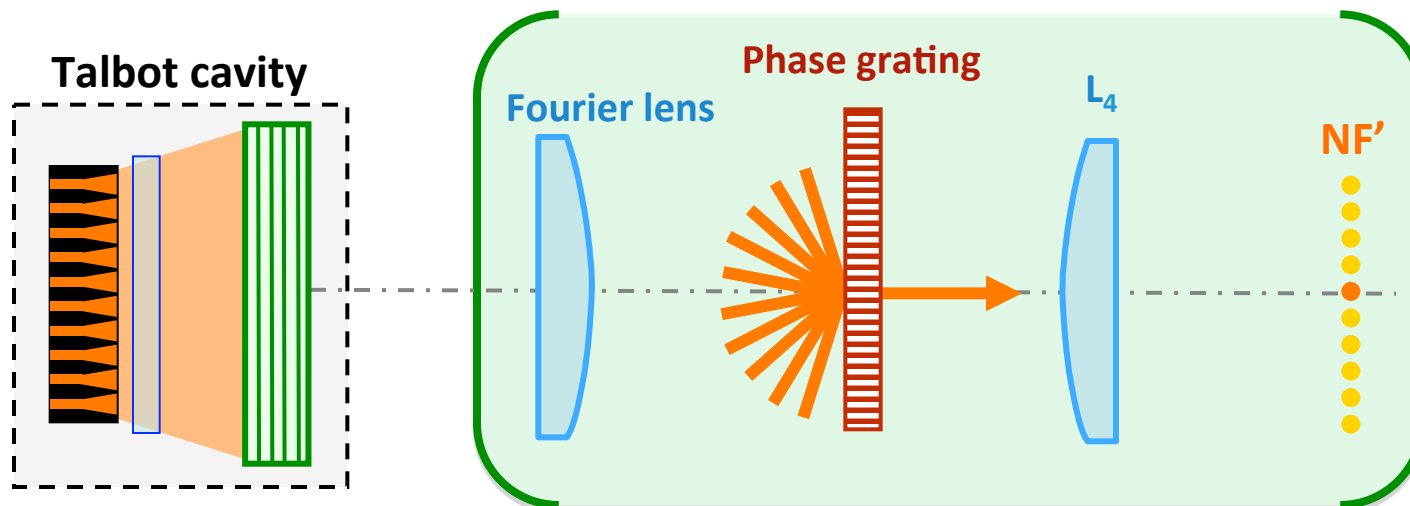

- Passive **phase-locking** of diode lasers in the Talbot external cavity
- + Passive **conversion** of the complex pattern in a Gaussian-like mode

Diffraction of the $N = 10$ coherent beams on a phase grating within 1 direction

⇒ **coherent superposition** of the emitters in the near-field plane NF'

Experimental superposition efficiency $\leq 51\%$

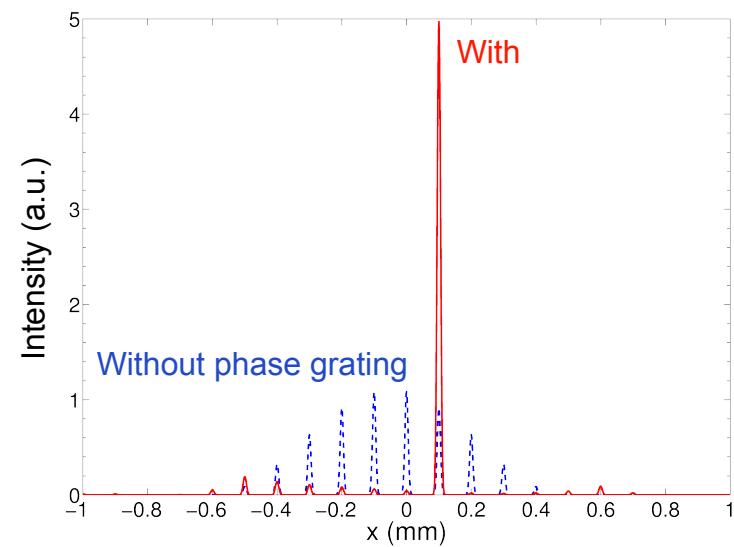

→ MOPA configuration

= **parallel amplification** of one seed laser in N **amplifiers**

Active electronic feedback

Linear phase-shift with control

→ Self-organizing lasers

= spontaneous operation in the phase-locked regime of N **lasers**
lasers in a **common external cavity**

Interferometric resonator

Self-imaging cavity

Passive optical feedback

Highly non-linear behavior

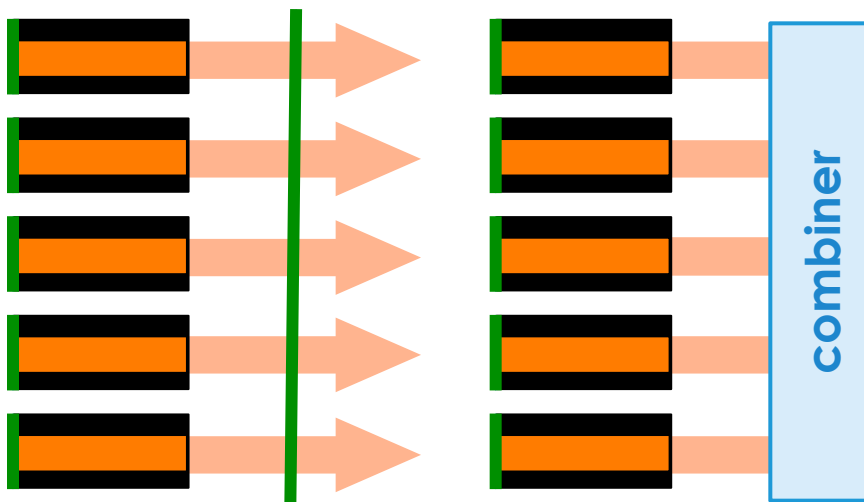
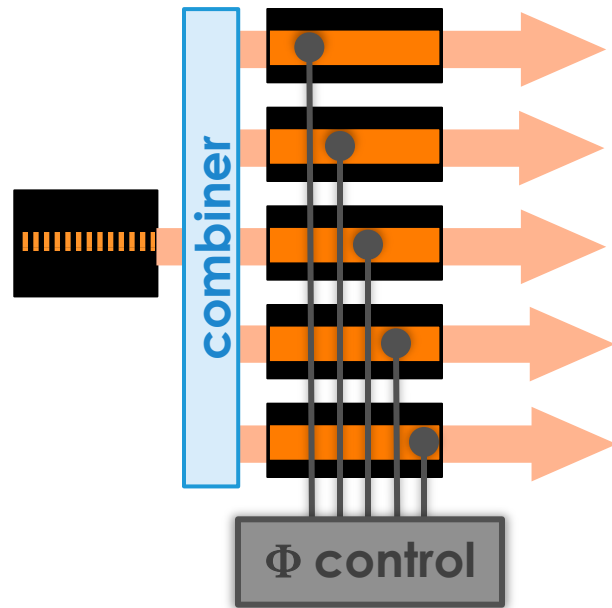

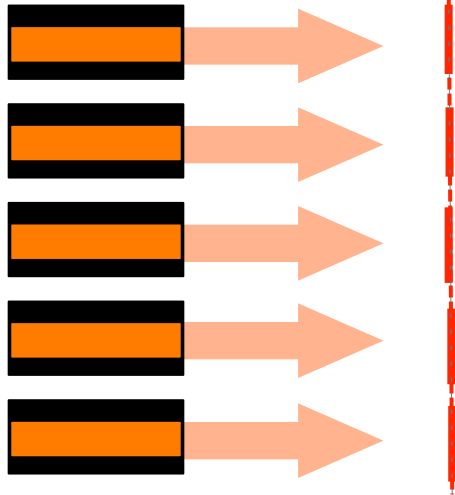

- New interest in coherent beam combining techniques in the laser community (fiber, solid-state, diodes ...)
- Better understanding of the limits
- High-brightness CBC laser sources have been demonstrated
- Scaling to large number of emitters is still challenging.
- Active vs passive ? Electronic vs optic ?
- Detailed analysis of the physics of passively phase-locked lasers still needed.
- Careful design & optimization of the CBC architecture in regard with the devices.
- New results in BRIDLE expected !



Special thanks to P. Georges, M. Hanna, D. Pabœuf, L. Leveque, G. Schimmel,
S. Janicot, I. Doyen